

## MULTI-FORMAT VIDEO SWITCHER

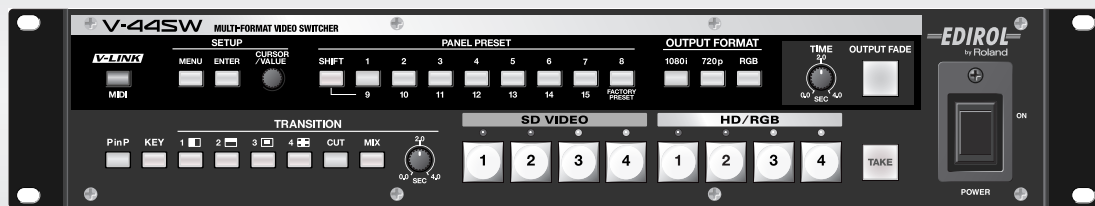

# V-44SW

## Owner's Manual



Before using this unit, carefully read the sections entitled: "IMPORTANT SAFETY INSTRUCTIONS" (p. 2), "USING THE UNIT SAFELY" (p. 6-7), and "IMPORTANT NOTES" (p. 8). These sections provide important information concerning the proper operation of the unit. Additionally, in order to feel assured that you have gained a good grasp of every feature provided by your new unit, Owner's Manual should be read in its entirety. The manual should be saved and kept on hand as a convenient reference.

**WARNING:** To reduce the risk of fire or electric shock, do not expose this apparatus to rain or moisture.

  
<b>ATTENTION:</b> RISQUE DE CHOC ELECTRIQUE NE PAS OUVRIR
<b>CAUTION:</b> TO REDUCE THE RISK OF ELECTRIC SHOCK, DO NOT REMOVE COVER (OR BACK). NO USER-SERVICEABLE PARTS INSIDE. REFER SERVICING TO QUALIFIED SERVICE PERSONNEL.



The lightning flash with arrowhead symbol, within an equilateral triangle, is intended to alert the user to the presence of uninsulated "dangerous voltage" within the product's enclosure that may be of sufficient magnitude to constitute a risk of electric shock to persons.



The exclamation point within an equilateral triangle is intended to alert the user to the presence of important operating and maintenance (servicing) instructions in the literature accompanying the product.

INSTRUCTIONS PERTAINING TO A RISK OF FIRE, ELECTRIC SHOCK, OR INJURY TO PERSONS.

## IMPORTANT SAFETY INSTRUCTIONS SAVE THESE INSTRUCTIONS

**WARNING** - When using electric products, basic precautions should always be followed, including the following:

1. Read these instructions.
2. Keep these instructions.
3. Heed all warnings.
4. Follow all instructions.
5. Do not use this apparatus near water.
6. Clean only with a dry cloth.
7. Do not block any of the ventilation openings. Install in accordance with the manufacturers instructions.
8. Do not install near any heat sources such as radiators, heat registers, stoves, or other apparatus (including amplifiers) that produce heat.
9. Do not defeat the safety purpose of the polarized or grounding-type plug. A polarized plug has two blades with one wider than the other. A grounding type plug has two blades and a third grounding prong. The wide blade or the third prong are provided for your safety. If the provided plug does not fit into your outlet, consult an electrician for replacement of the obsolete outlet.
10. Protect the power cord from being walked on or pinched particularly at plugs, convenience receptacles, and the point where they exit from the apparatus.
11. Only use attachments/accessories specified by the manufacturer.
12. Unplug this apparatus during lightning storms or when unused for long periods of time.
13. Refer all servicing to qualified service personnel. Servicing is required when the apparatus has been damaged in any way, such as power-supply cord or plug is damaged, liquid has been spilled or objects have fallen into the apparatus, the apparatus has been exposed to rain or moisture, does not operate normally, or has been dropped.

For the U.K.

**WARNING:** THIS APPARATUS MUST BE EARTHED

**IMPORTANT:** THE WIRES IN THIS MAINS LEAD ARE COLOURED IN ACCORDANCE WITH THE FOLLOWING CODE.  
GREEN-AND-YELLOW: EARTH, BLUE: NEUTRAL, BROWN: LIVE

As the colours of the wires in the mains lead of this apparatus may not correspond with the coloured markings identifying the terminals in your plug, proceed as follows:

The wire which is coloured GREEN-AND-YELLOW must be connected to the terminal in the plug which is marked by the letter E or by the safety earth symbol  or coloured GREEN or GREEN-AND-YELLOW.

The wire which is coloured BLUE must be connected to the terminal which is marked with the letter N or coloured BLACK.

The wire which is coloured BROWN must be connected to the terminal which is marked with the letter L or coloured RED.

# Table of Contents

<b>Introduction</b> .....	<b>4</b>	<b>Switching Video</b> .....	<b>36</b>
<b>Main Features</b> .....	<b>4</b>	Selecting the Video Switching Mode .....	36
<b>USING THE UNIT SAFELY</b> .....	<b>6</b>	Switching Video in Direct Mode .....	36
<b>IMPORTANT NOTES</b> .....	<b>8</b>	Switching in Preset Mode .....	37
<b>Overview of the V-44SW</b> .....	<b>9</b>	Selecting the Effects To Be Applied in Switching .....	38
Organization of the V-44SW .....	9	Customizing Wipe Transitions .....	38
About the Operating Modes .....	9	<b>Adding Effects to the Video</b> .....	<b>39</b>
<b>Panel Descriptions</b> .....	<b>10</b>	Adding the Picture in Picture (P in P) Effect .....	39
Front Panel .....	10	Advanced P in P Effect Settings .....	40
Top Panel .....	11	Applying the Key Composite Effect .....	41
Rear Panel .....	12	Advanced Key Composite Settings .....	41
<b>Setup and Settings Guide</b> .....	<b>13</b>	<b>Registering Often-Used Settings (Panel Presets)</b> .....	<b>42</b>
<b>1. Confirm the Contents of the Package</b> .....	<b>13</b>	Registering Presets .....	42
<b>2. Set Up and Make the Connections</b> .....	<b>13</b>	Calling Up Presets .....	42
<b>3. Turn on the Power and Output the Video</b> .....	<b>16</b>	Copying Presets .....	43
<b>4. Adjusting the Video Image Quality</b> .....	<b>17</b>	Exchanging Presets Between PANEL PRESET Buttons .....	43
<b>5. Turning Off the Power and Quitting</b> .....	<b>17</b>	<b>Using the V-44SW with Other Devices</b> .....	<b>44</b>
<b>Examples for Connecting and Setting the V-44SW</b> .....	<b>18</b>	Using the V-44SW with a V-440HD for Multi-Screen Output .....	44
<b>Quick Guide</b> .....	<b>22</b>	Switching the V-44SW's Operating Modes .....	44
<b>Try Outputting Some Video</b> .....	<b>22</b>	Using MIDI .....	45
<b>Try Adding Some Screen Transition Effects</b> .....	<b>23</b>	About MIDI .....	45
<b>Operation Guide</b> .....	<b>25</b>	Controlling the V-44SW from an External Device Via MIDI .....	46
<b>Basic Operation</b> .....	<b>26</b>	Controlling the V-44SW from a PR-80/50 .....	47
Turning the Power On .....	26	Transmitting Settings to Another V-44SW (Bulk Dump) .....	47
Turning the Power Off .....	26	Control Using V-LINK .....	48
Setting the Various Functions (Menu) .....	26	Controlling the V-44SW from an External Device	
Getting Ready to Display Menus .....	26	Using the REMOTE Connector .....	48
Working with the Menus .....	27	Backing Up the V-44SW's Settings to a Computer .....	49
Menu Display Shortcuts .....	27	<b>Appendices</b> .....	<b>51</b>
Fading Out the Final Output .....	28	<b>Troubleshooting</b> .....	<b>52</b>
Using the [TIME] Knob to Fade Out the Video .....	28	<b>Menu List</b> .....	<b>54</b>
Restoring the Original Factory Default Settings (Factory Reset) .....	29	<b>MIDI Implementation Chart</b> .....	<b>59</b>
<b>Setting the Input and Output</b> .....	<b>30</b>	<b>REMOTE Command Reference</b> .....	<b>60</b>
Setting the Output .....	30	<b>Connector Specifications</b> .....	<b>62</b>
Setting the Output Format .....	30	HD/RGB IN OUT Connectors .....	62
Setting the Output .....	31	REMOTE Connector .....	62
Setting the HD/RGB Input .....	32	<b>About Connection Cables Used with the</b>	
Setting the SD Input .....	34	<b>Component Inputs and Outputs</b> .....	<b>63</b>
Displaying a Test Pattern .....	35	<b>Menu Settings Memo</b> .....	<b>64</b>
Selecting NTSC or PAL Format .....	35	<b>Panel Preset Memo</b> .....	<b>66</b>
		<b>Block Diagram</b> .....	<b>67</b>
		<b>Main Specifications</b> .....	<b>68</b>
		<b>Index</b> .....	<b>69</b>

# Main Features

## Seamless switching of HD, RGB, and SD format video, all with this single device

- You can enjoy free use of the four SD inputs and four inputs for HD video or RGB video from computers.

The V-44SW is compatible with HD (1080i/720p; component), SD (S-Video; component), and RGB signal (VGA-SXGA) video formats, allowing you to handle video from HD cameras, SD cameras, and computers simultaneously without concerns about input formats.

For more on the formats handled by the V-44SW, refer to p. 54 and p. 56.

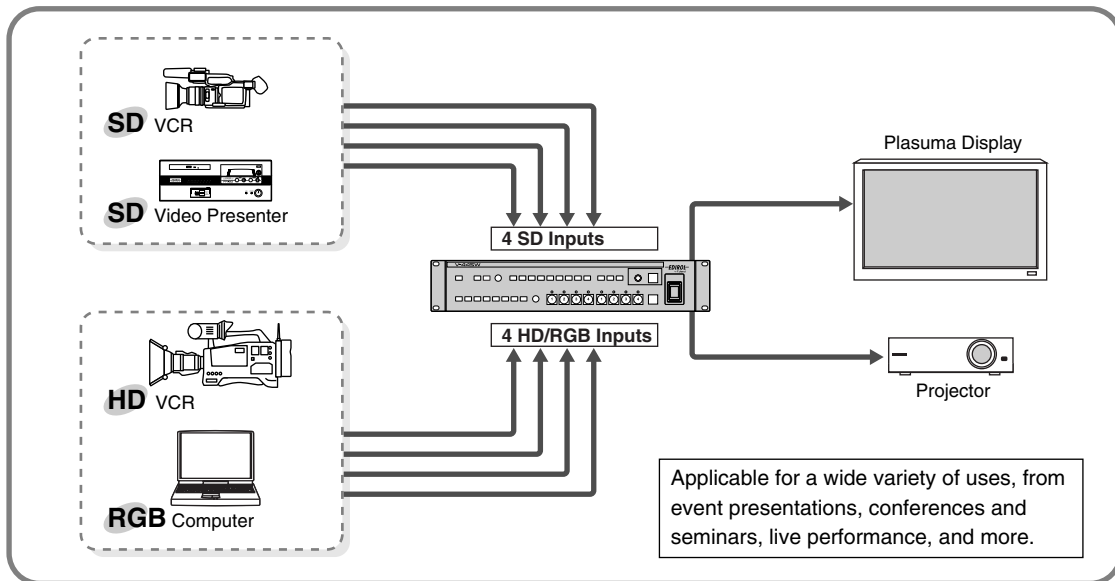

## Features Two Video Switching Modes

The V-44SW offers two different modes for switching video, a "Direct mode" and a "Preset mode."

- In Direct mode you can switch video with the press of a single button.
- In Preset mode, you can confirm the input video with the preview monitor before switching the video.

You can check the video from all inputs in one preview monitor, all without affecting the final output video. This two-step process, first confirming the input video and then switching the final output video, helps prevent mistakes in switching.

### Video Signals Handled by the V-44SW

<b>HD</b>	An abbreviation for "High Definition," HD is a generic term for television formats that, in comparison to conventional TV formats, provide higher resolution and an improved angle of view, and deliver a heightened sense of presence by means of large-screen. This is also referred to as HDTV.  Although there are a number of different types of HD, which can vary depending on the country where the technology was developed, the V-440HD utilizes the standards recommended in BT.709-3, established by the ITU in February, 1998.
<b>RGB</b>	This format, used for output of video images with computers and other digital devices, uses video signals whereby each of three main colors, red (R), green (G), and blue (B), are handled separately.
<b>SD</b>	An abbreviation for Standard Definition, this refers to formats currently in general use (such as 480i), as opposed to HD (High Definition).

## Effects Included

- **You can have transitions appear smoothly when switching video.**

The V-44SW features a selection of screen transition effects, including six types of wipe effects as well as cut and mix effects. You can have such screen transition effects be applied simply by selecting a button.

- **You can composite video from two sources.**

The V-44SW includes three types of composite effects (Picture in Picture (P in P), Luminance Key, and Chroma Key). You can, for example, use Chroma Key to take text appearing on your computer screen and display it as a title.

## Includes Panel Preset Functions

- **Call up complex configurations of settings just by pressing a button.**

You can register button settings and Picture in Picture (P in P) and other special effect settings as presets. You can then call up the registered settings instantly just by pressing the assigned button.

## Cut Unneeded Video

- **You can have black (or white) screens output in the final output video during breaks and at the ends of videos.**

## Equipped with Improved High-Performance Converter

- **This converts SD video to HD/RGB format for high-quality image output.**

## Link Operation with Edirol V-440HDs, Control Remotely from External Devices

- **Multi-screen presentations**

Using simple settings, you can synchronize operation of multiple V-44SWs with an Edirol V-440HD as the master device to have a single video source displayed across multiple display screens.

- **Equipped with REMOTE connector**

The V-44SW can be controlled remotely (serial control) from a computer or other external device. You can also back up the V-44SW's settings to computers and other devices.

- **Also comes equipped with MIDI connectors**

You can link operation of multiple V-44SWs simply with MIDI connections, without needing to set up any special control device.

MIDI connections also allow you to transfer the V-44SW's settings to other V-44SWs and to control the V-44SW from an Edirol PR Series devices

# USING THE UNIT SAFELY

## INSTRUCTIONS FOR THE PREVENTION OF FIRE, ELECTRIC SHOCK, OR INJURY TO PERSONS

### About ⚠ WARNING and ⚠ CAUTION Notices

<b>⚠ WARNING</b>	Used for instructions intended to alert the user to the risk of death or severe injury should the unit be used improperly.
<b>⚠ CAUTION</b>	Used for instructions intended to alert the user to the risk of injury or material damage should the unit be used improperly. * Material damage refers to damage or other adverse effects caused with respect to the home and all its furnishings, as well to domestic animals or pets.

### About the Symbols

	The ⚠ symbol alerts the user to important instructions or warnings. The specific meaning of the symbol is determined by the design contained within the triangle. In the case of the symbol at left, it is used for general cautions, warnings, or alerts to danger.
	The ⓧ symbol alerts the user to items that must never be carried out (are forbidden). The specific thing that must not be done is indicated by the design contained within the circle. In the case of the symbol at left, it means that the unit must never be disassembled.
	The ● symbol alerts the user to things that must be carried out. The specific thing that must be done is indicated by the design contained within the circle. In the case of the symbol at left, it means that the power-cord plug must be unplugged from the outlet.

## ALWAYS OBSERVE THE FOLLOWING

### ⚠ WARNING

- Before using this unit, make sure to read the instructions below, and the Owner's Manual.
- Connect mains plug of this model to a mains socket outlet with a protective earthing connection.
- Do not open or perform any internal modifications on the unit.
- Do not attempt to repair the unit, or replace parts within it (except when this manual provides specific instructions directing you to do so). Refer all servicing to your retailer, the nearest EDIROL/Roland Service Center, or an authorized EDIROL/Roland distributor, as listed on the "Information" page.
- Never use or store the unit in places that are:
  - Subject to temperature extremes (e.g., direct sunlight in an enclosed vehicle, near a heating duct, on top of heat-generating equipment); or are
  - Damp (e.g., baths, washrooms, on wet floors); or are
  - Humid; or are
  - Exposed to rain; or are
  - Dusty; or are
  - Subject to high levels of vibration.
- Make sure you always have the unit placed so it is level and sure to remain stable. Never place it on stands that could wobble, or on inclined surfaces.

### ⚠ WARNING

- The unit should be connected to a power supply only of the type described in the operating instructions, or as marked on the rear side of unit.
- Use only the attached power-supply cord. Also, the supplied power cord must not be used with any other device.
- Do not excessively twist or bend the power cord, nor place heavy objects on it. Doing so can damage the cord, producing severed elements and short circuits. Damaged cords are fire and shock hazards!
- Do not allow any objects (e.g., flammable material, coins, pins); or liquids of any kind (water, soft drinks, etc.) to penetrate the unit.
- Immediately turn the power off, remove the power plug from the outlet, and request servicing by your retailer, the nearest EDIROL/Roland Service Center, or an authorized EDIROL/Roland distributor, as listed on the "Information" page when:
  - The power-supply cord, or the plug has been damaged; or
  - If smoke or unusual odor occurs
  - Objects have fallen into, or liquid has been spilled onto the unit; or
  - The unit has been exposed to rain (or otherwise has become wet); or
  - The unit does not appear to operate normally or exhibits a marked change in performance.

**⚠ WARNING**

- Protect the unit from strong impact. (Do not drop it!) 

---

- Do not force the unit's power-supply cord to share an outlet with an unreasonable number of other devices. Be especially careful when using extension cords—the total power used by all devices you have connected to the extension cord's outlet must never exceed the power rating (watts/amperes) for the extension cord. Excessive loads can cause the insulation on the cord to heat up and eventually melt through. 

---

- Before using the unit in a foreign country, consult with your retailer, the nearest EDIROL/Roland Service Center, or an authorized EDIROL/Roland distributor, as listed on the "Information" page. 

---

- Do not put anything that contains water (e.g., flower vases) on this unit. Also, avoid the use of insecticides, perfumes, alcohol, nail polish, spray cans, etc., near the unit. Swiftly wipe away any liquid that spills on the unit using a dry, soft cloth. 

**⚠ CAUTION**

- The unit should be located so that its location or position does not interfere with its proper ventilation. 

---

- Always grasp only the plug on the power-supply cord when plugging into, or unplugging from, an outlet or this unit. 

---

- At regular intervals, you should unplug the power plug and clean it by using a dry cloth to wipe all dust and other accumulations away from its prongs. Also, disconnect the power plug from the power outlet whenever the unit is to remain unused for an extended period of time. Any accumulation of dust between the power plug and the power outlet can result in poor insulation and lead to fire. 

---

- Try to prevent cords and cables from becoming entangled. Also, all cords and cables should be placed so they are out of the reach of children. 

---

- Never climb on top of, nor place heavy objects on the unit. 

---

- Never handle the power cord or its plugs with wet hands when plugging into, or unplugging from, an outlet or this unit. 

---

- Before moving the unit, disconnect the power plug from the outlet, and pull out all cords from external devices. 

---

- Before cleaning the unit, turn off the power and unplug the power cord from the outlet. 

---

- Whenever you suspect the possibility of lightning in your area, pull the plug on the power cord out of the outlet. 

---

- Should you remove the grounding terminal screw, keep them in a safe place out of children's reach, so there is no chance of them being swallowed accidentally. 

---

- The side panels of this unit may become hot, so take care to avoid burns. 

# IMPORTANT NOTES

In addition to the items listed under “IMPORTANT SAFETY INSTRUCTIONS” and “USING THE UNIT SAFELY” on pages 2 and 6–7, please read and observe the following:

## Power Supply

- Do not connect this unit to same electrical outlet that is being used by an electrical appliance that is controlled by an inverter (such as a refrigerator, washing machine, microwave oven, or air conditioner), or that contains a motor. Depending on the way in which the electrical appliance is used, power supply noise may cause this unit to malfunction or may produce audible noise. If it is not practical to use a separate electrical outlet, connect a power supply noise filter between this unit and the electrical outlet.
- Before connecting this unit to other devices, turn off the power to all units. This will help prevent malfunctions and/or damage to video monitors or other devices.
- Although the LEDs are switched off when the POWER switch is switched off, this does not mean that the unit has been completely disconnected from the source of power. If you need to turn off the power completely, first turn off the POWER switch, then unplug the power cord from the power outlet. For this reason, the outlet into which you choose to connect the power cord’s plug should be one that is within easy reach and readily accessible.
- To ensure long service life, be sure to shut off the power whenever the unit is not being used and limit continuous operation as much as possible.

## Placement

- This device may interfere with radio and television reception. Do not use this device in the vicinity of such receivers.
- Noise may be produced if wireless communications devices, such as cell phones, are operated in the vicinity of this unit. Such noise could occur when receiving or initiating a call, or while conversing. Should you experience such problems, you should relocate such wireless devices so they are at a greater distance from this unit, or switch them off.
- When moved from one location to another where the temperature and/or humidity is very different, water droplets (condensation) may form inside the unit. Damage or malfunction may result if you attempt to use the unit in this condition. Therefore, before using the unit, you must allow it to stand for several hours, until the condensation has completely evaporated.
- Depending on the material and temperature of the surface on which you place the unit, its rubber feet may discolor or mar the surface.  
You can place a piece of felt or cloth under the rubber feet to prevent this from happening. If you do so, please make sure that the unit will not slip or move accidentally.

## Maintenance

- For everyday cleaning wipe the unit with a soft, dry cloth or one that has been slightly dampened with water. To remove stubborn dirt, use a cloth impregnated with a mild, non-abrasive detergent. Afterwards, be sure to wipe the unit thoroughly with a soft, dry cloth.
- Never use benzine, thinners, alcohol or solvents of any kind, to avoid the possibility of discoloration and/or deformation.

## Repairs and Data

- Please be aware that all data contained in the unit’s memory may be lost when the unit is sent for repairs. Important data should always be backed up in another MIDI device (e.g., a sequencer), or written down on paper (when possible) repairs, due care is taken to avoid the loss of data. However, in certain cases (such as when circuitry related to memory itself is out of order), we regret that it may not be possible to restore the data, and Roland assumes no liability concerning such loss of data.

## Additional Precautions

- Damage or breakdown of the unit or mistakes in operation may result in the loss of data stored in memory. To avoid problems in the event of the loss of important data, write down the settings or follow the instructions to save the data to your computer (p. 49) or other external device.
- Unfortunately, it may be impossible to restore the contents of data that was stored in another MIDI device (e.g., a sequencer) once it has been lost. Roland Corporation assumes no liability concerning such loss of data.
- Use a reasonable amount of care when using the unit’s buttons, sliders, or other controls; and when using its jacks and connectors. Rough handling can lead to malfunctions.
- When connecting / disconnecting all cables, grasp the connector itself—never pull on the cable. This way you will avoid causing shorts, or damage to the cable’s internal elements.
- A small amount of heat will radiate from the unit during normal operation.
- When you need to transport the unit, package it in the box (including padding) that it came in, if possible. Otherwise, you will need to use equivalent packaging materials.
- This device allows you to switch images or turn video effects on/off at high speed. For some people, viewing such images can cause headache, nausea, or other discomfort. Do not use this device to create video that might cause these types of health problems. Roland Corporation will accept no responsibility for any such health problems that may occur in yourself or in viewers.

\* Microsoft and Windows are registered trademarks of Microsoft Corporation.



# Overview of the V-44SW

## Organization of the V-44SW

The V-44SW comprises two main sections, an “SD section,” used for managing all SD video, and an “HD/RGB section,” which is used to mix all video signals.

Composite video signals and S-video signals are mixed in the SD section. The resulting mixes are sent to the HD/RGB section and mixed with the HD and RGB video. The combined video is then output as the final output in either HD or RGB format.

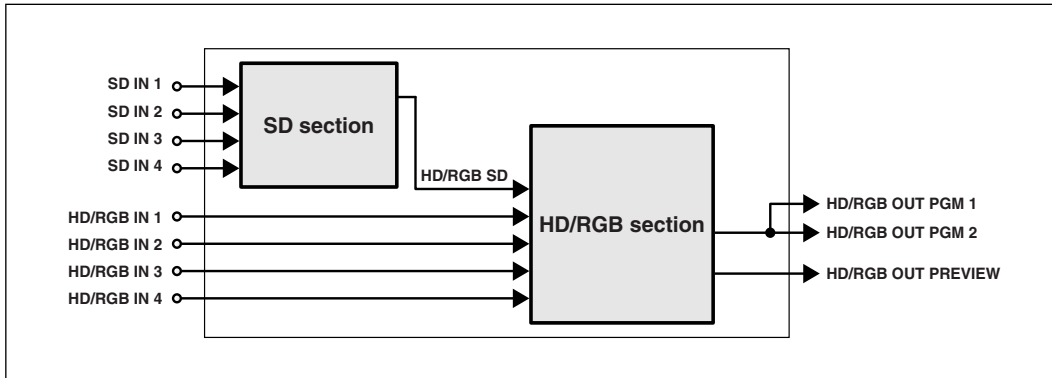

For more details about how the mixer is arranged, refer to the “Block Diagram” (p. 67).

### About “Channels”

Each of the V-44SW’s video inputs is called a “channel.” The SD and HD/RGB sections each feature Channels 1–4, with each channel being independently controlled. Each “channel” is the equivalent of a “path” for the video signals.

## About the Operating Modes

In addition to the V-44SW’s normal mode of operation, there is another mode referred to as “**V-440HD Slave mode.**” V-440HD Slave mode is used only when operation of the V-44SW is linked to an Edirol V-440HD. When switched to V-440HD Slave mode, the V-44SW then functions as slave device to the V-440HD. You cannot use the V-44SW’s panel controls to switch video while the unit is in V-440HD Slave mode.

For instructions on switching operational modes, refer to “Switching the V-44SW’s Operating Modes” (p. 44).

# Panel Descriptions

## Front Panel

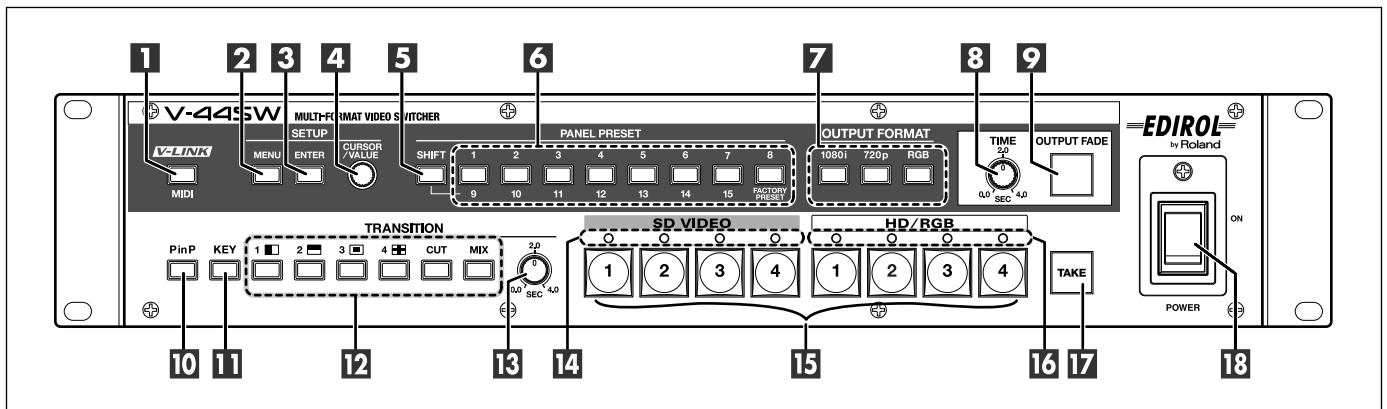

### 1 [MIDI] Button

- This switches reception of MIDI signals on and off. When switched off, the [MIDI] button is unlit, and the V-44SW does not receive MIDI signals.

☞ “Temporarily Cutting Linked Operation” (p. 46)

- When the [MIDI] button’s function is set to “V-LINK Indicator,” the button is lit when V-LINK mode is on, and off when V-LINK mode is off.

☞ “Control Using V-LINK” (p. 48)

### 2 [MENU] Button

Press this button to display the Main menu in the television monitor connected to the MENU connector (p. 12).

If you have shifted to a lower level menu, pressing this takes you back to the immediately preceding menu (the level above).

The [MENU] button flashes while the menu is displayed.

☞ “Setting the Various Functions (Menu)” (p. 26)

### 3 [ENTER] Button

Pressing this button confirms your choice of the menu parameter that’s currently selected and advances the screen to the next (lower level) menu. This is also pressed to respond with “Yes” to messages appearing on the screen when using menu operations.

☞ “Working with the Menus” (p. 27)

### 4 [CURSOR/VALUE] Knob

This moves the cursor appearing in the menu.

When the cursor is located at the value set for a menu parameter, rotating the knob changes the value.

☞ “Working with the Menus” (p. 27)

### 5 [SHIFT] Button

This switches the functions assigned to the PANEL PRESET buttons (6).

☞ “Registering Often-Used Settings (Panel Presets)” (p. 42)

### 6 PANEL PRESET Buttons

Use these buttons to register and call up button settings, settings for other special effects such as the Picture in Picture (P in P), and other settings as presets.

The presets change depending on whether the [SHIFT] button is lit or unlit.

[SHIFT] Button	PANEL PRESET Buttons
Off	Register and call up Presets 1–8
Lit	Register and call up Presets 9–15 Calls up the factory presets

☞ “Registering Often-Used Settings (Panel Presets)” (p. 42)

### 7 OUTPUT FORMAT

#### [1080i] [720p] [RGB] Buttons

These select the format of the video output from the HD/RGB OUT PGM connectors. The selected button lights.

☞ “Setting the Output Format” (p. 30)

Button	Output Format (Factory Setting)
[1080i]	1080/60i
[720p]	720/60p
[RGB]	1024x768/60

\* You can change the output formats selectable with these buttons. ☞ “Changing the Output Format” (p. 30)

### 8 [TIME] Knob

This sets the time for the video to fade out after the [OUTPUT FADE] button (9) is pressed.

☞ “Fading Out the Final Output” (p. 28)

### 9 [OUTPUT FADE] Button

Pressing this causes the video output from the HD/RGB OUT PGM connector (p. 12) to fade out.

Pressing the [OUTPUT FADE] button after the video has faded out fades the video in again.

☞ “Fading Out the Final Output” (p. 28)

### 10 [P in P] Button

This switches the Picture in Picture effect on and off. The [P in P] button lights when the effect is on.

☞ “Adding the Picture in Picture (P in P) Effect” (p. 39)

### 11 [KEY] Button

This switches the Key Composite effect on and off. The [KEY] button lights when the effect is on.  
 ☞ “Applying the Key Composite Effect” (p. 41)

### 12 TRANSITION Select Buttons

These select the effect to be applied when the video images are switched. The selected button lights up.  
 ☞ “Selecting the Effects To Be Applied in Switching” (p. 38)

#### ● WIPE [1]–[4] Buttons

These buttons switch the video images by replacing the current video with the subsequent video, which spreads across the screen (wipe effect).

The time used in switching the video with the wipe effects is specified with the [TRANSITION TIME] knob (13).

#### ● [CUT] Button

Use this button to have video switch instantly.

#### ● [MIX] Button

This switches the video by gradually fading out the previous video while fading in the subsequent video image over it until the new video is fully visible (dissolve effect).

The time used in switching the video is specified with the [TRANSITION TIME] knob (13).

### 13 [TRANSITION TIME] Knob

This sets the time (in seconds) taken in switching videos.  
 ☞ “Selecting the Effects To Be Applied in Switching” (p. 38)

### 14 SD VIDEO 1–4 Indicators

These indicate the status of video signals input to the S-VIDEO IN connectors (p. 12) or COMPOSITE IN connectors (p. 12)

Lit (Red)	Composite video signals input
Lit (Green)	S-Video video signals input
Off	No signals input

### 15 Channel Select Buttons

These switch the video images being input. There are two ways to switch input video.  
 ☞ “Switching Video” (p. 36)

#### ● SD VIDEO [1]–[4] Buttons

These switch the video being input to the S-VIDEO IN connectors and COMPOSITE IN connectors.

#### ● HD/RGB [1]–[4] Buttons

These switch the video being input to the HD/RGB IN connectors

### 16 HD/RGB 1–4 Indicators

These indicate the status of video signals input to the HD/RGB IN connectors (p. 12).

Lit (Red)	RGB signals input
Lit (Green)	Component signals input
Off	No signals input

### 17 [TAKE] Button

This takes the video currently being output from the preview monitor connected to the HD/RGB OUT PREVIEW connector (p. 12) and outputs it from the HD/RGB OUT PGM connector.

Use this when switching video in Preset mode and to display video with key composite and other special effects applied.

☞ “Switching in Preset Mode” (p. 37)

☞ “Adding Effects to the Video” (p. 39)

### 18 [POWER] Switch

This switches the power on and off.

☞ “Turning the Power On” (p. 26)

## Top Panel

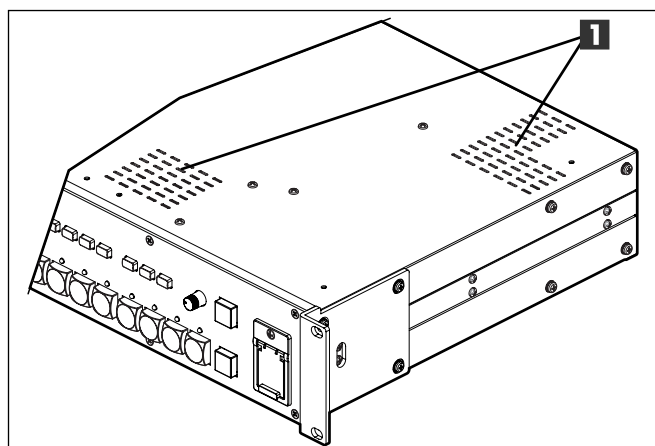

### 1 Cooling Fan Exhaust Vents

The V-44SW contains a cooling fan that prevents it from overheating. The fan expels hot air through this exhaust vents.

#### NOTE

- Do not allow the cooling fan exhaust vents to become blocked. Obstruction of the vents will cause temperatures inside the V-44SW to rise, and this heat may result in damage to the unit.

## Rear Panel

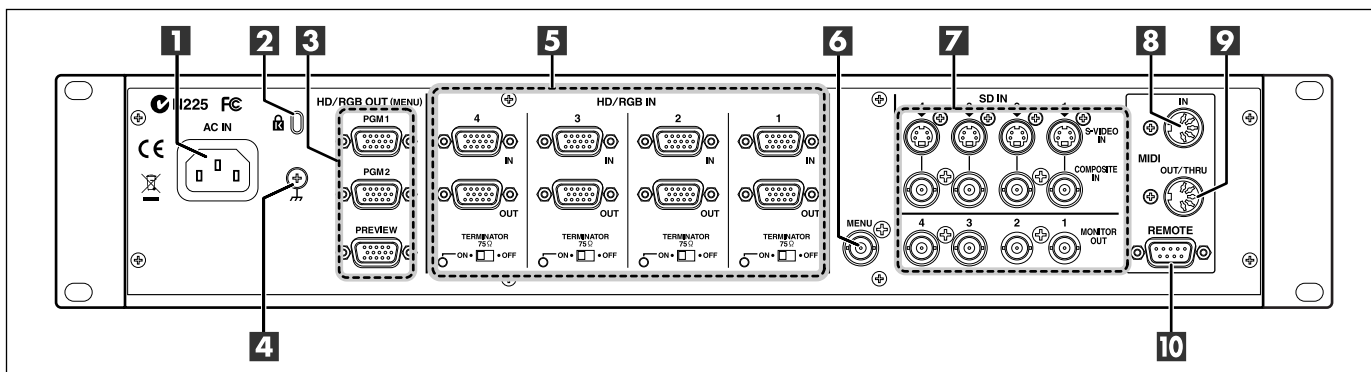

### 1 AC Inlet

Connect the supplied power cord here.

### 2 Security Slot (K)

You can attach a commercially available security lock here.

<http://www.kensington.com/>

### 3 HD/RGB OUT

#### ● HD/RGB OUT PGM Connectors 1, 2

These output the final output video as analog component signals or RGB signals.

#### ● HD/RGB OUT PREVIEW Connector

This outputs the final output video preview screen as analog component signals or RGB signals.

\* You can also display menus in the video output from the HD/RGB OUT PGM/PREVIEW connector. ☞ “If You Want to Display Menus in the Final Output Video” (p. 26)

### 4 Ground Terminal

Connect this terminal to an external ground or run it to earth.

☞ “About the Ground Terminal” (p. 15)

### 5 HD/RGB IN

These input analog component signals or RGB signals from up to four systems.

#### ● HD/RGB IN Connectors 1–4

These are D-sub connectors for input of analog component or RGB signals.

#### ● HD/RGB LOOP THRU OUT Connectors 1–4

These are D-sub connectors that output (loop thru) the signals input to the HD/RGB IN connector on the same channel without alteration.

#### ● [TERMINATOR 75Ω] Switches 1–4

Normally, these are set to ON.

Set these to OFF when using loop thru.

☞ “About Loop Thru” (p. 15)

### 6 MENU Connector

The menu is output from here.

☞ “Setting the Various Functions (Menu)” (p. 26)

### 7 SD IN

These input composite video signals or S-Video signals from up to four systems.

The V-44SW is set at the factory so that if video is input via both the S-VIDEO IN connector and the COMPOSITE IN connector for the same channel, the S-VIDEO IN connector’s input takes precedence.

☞ “About the S-VIDEO IN Connectors and COMPOSITE IN Connectors” (p. 15)

#### ● COMPOSITE IN Connectors 1–4

These are BNC connectors for input of composite video signals. You can connect video devices equipped with composite video output connectors here.

#### ● S-VIDEO IN Connectors 1–4

These are BNC connectors for input of S-Video video signals. You can connect video devices equipped with S-Video video output connectors here.

#### ● MONITOR OUT Connectors 1–4

These are BNC connectors that output composite video for video images input to the S-VIDEO IN connectors and COMPOSITE IN connectors.

You can connect a television monitor equipped with composite video input connectors here to confirm the video images in each channel.

### 8 MIDI IN Connector

MIDI messages from the connected external MIDI device are received here.

☞ “Using the V-44SW with Other Devices” (p. 44)

### 9 MIDI OUT/THRU Connector

Transmits MIDI messages to an external MIDI device.

You can also use this connector as a THRU output for MIDI signals received at the MIDI IN connector.

☞ “Using the V-44SW with Other Devices” (p. 44)

### 10 REMOTE Connector

Use this connector when using serial control to run the V-44SW from a computer or other such device.

☞ “Controlling the V-44SW from an External Device Using the REMOTE Connector” (p. 48)

# Setup and Settings Guide

## 1. Confirm the Contents of the Package

The V-44SW includes the following items. Please take a moment to confirm that all of these items have been included with the V-44SW. If you find that any item is missing, contact the nearest authorized EDIROL/Roland distributor in your country.

**V-44SW**

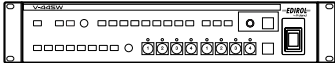

**Owner's Manual**

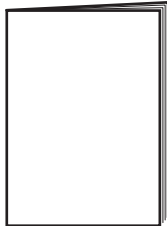

**Operation Reference**

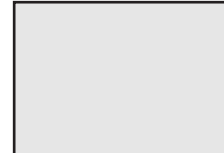

**Power Cord**

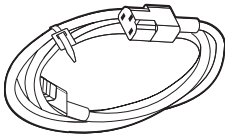

## 2. Set Up and Make the Connections

### Precautions for Rack Mounting

- When mounting the V-44SW in a rack or other such enclosure, observe the following precautions to ensure efficient and effective cooling.
  - Ensure that the location provides good air flow and ventilation.
  - Do not allow the vents to become obstructed.
  - Avoid using the V-44SW in sealed-type rack mounts. As this type of rack does not permit heated air within the rack to be expelled, the heated air is drawn into the V-44SW as a result, thus preventing adequately efficient cooling.
  - If the rack's rear panel is not removable, ensure that a ventilation port or exhaust fan is provided at the top of the rack's rear panel to expel any accumulated heat.
  - If the V-44SW is mounted in a portable rack, remove both the front and rear rack covers before use to ensure that the V-44SW's front and rear panels remain unobstructed.
- Use due caution when mounting the V-44SW in a rack or other enclosure so you don't get your fingers wedged or pinched.

### Connecting the Monitor Used for Displaying the Menus

Connect a television monitor to the MENU connector (☞ p. 14).

Video brightness and contrast adjustments and a variety of other settings for the V-44SW are made in the menus displayed. These menus appear in the television monitor connected to the MENU connector.

- You can have the menus appear in the display showing the final output video.
  - Hold down the [SHIFT] button and press the [MENU] button; the menu from the "HD/RGB OUT PGM connector/HD/RGB OUT PREVIEW connector" is alternately displayed and hidden each time the [MENU] button is pressed.

## Device Connections

- Whenever connecting the V-44SW to other devices, always turn off the power to all devices to prevent malfunction and/or damage to video monitors and other equipment.
- Be sure to use cables and adapter plugs with the proper connectors matching those of the other devices you are using.
- Refer to “Examples for Connecting and Setting the V-44SW” (p. 18).

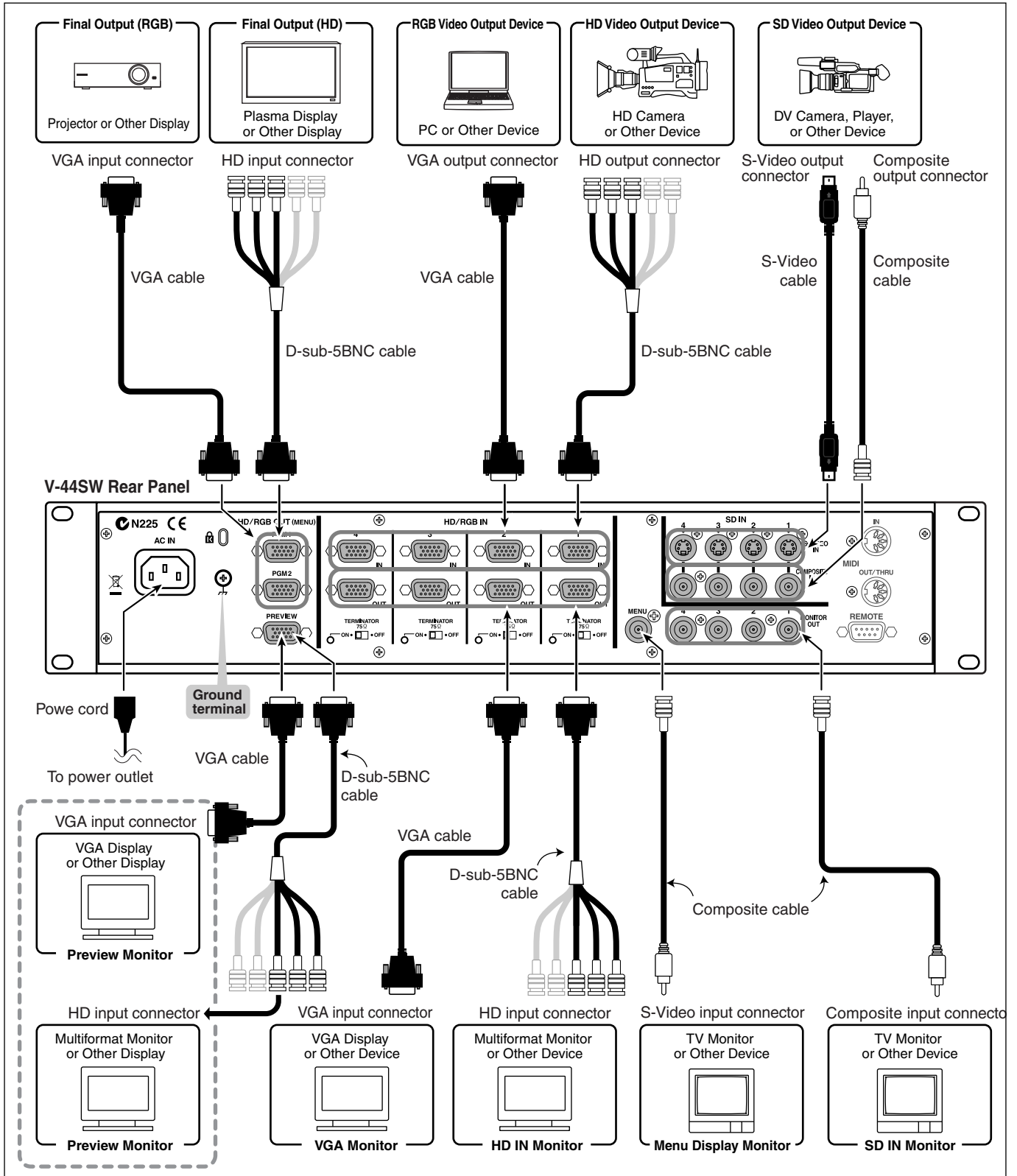

### About the S-VIDEO IN Connectors and COMPOSITE IN Connectors

The V-44SW is set at the factory so that if video is input via both the S-VIDEO IN connector and the COMPOSITE IN connector for the same channel, the S-VIDEO IN connector's input takes precedence.

- If you want to give priority to the input from the COMPOSITE IN connector, select the input channel with "2. SD Input" in the menu, then set "1: SD Input Select" to "Composite." For more on menu operations, refer to "Working with the Menus" (p. 27).

### About Formats for Video Input Through the HD/RGB IN Connectors

The V-44SW is set at the factory to determine the format of video input through the HD/RGB IN connectors automatically.

- If you want to specify the video format for the HD/RGB inputs, select the input channel with "3. HD/RGB Input" in the menu, set "2: Input Format" to "Manual," then select the video format with "2: Input Format." For more on menu operations, refer to "Working with the Menus" (p. 27).

### About the RGB Input

The V-44SW's RGB input is not compatible with the "sync-on-green" signal format.

### About Loop Thru

You can link the V-44SW's HD/RGB IN and HD/RGB LOOP THRU OUT connectors for the same channel.

For example, if you are inputting analog component signals to the HD/RGB IN connector on Channel 1, you can output the same signals from the Channel 1 HD/RGB LOOP THRU OUT connector. This function is referred to as "loop thru."

You can use loop thru to take the video from each input and output it directly to a television monitor to confirm the images or when using the V-44SW as a slave device with Multi-Screen output (p. 44).

When using loop thru, set the [TERMINATOR 75Ω] switch to OFF.

#### NOTE

- **Set the [TERMINATOR 75Ω] switch to on when loop thru function is not used**

When not using loop thru, some devices will not function properly unless the [TERMINATOR 75Ω] switch is set to ON.

- **Using loop thru more than twice or more in the same pass causes attenuation of the video.**

In connecting V-44SWs and V-440HDs using loop thru, once you have three or more devices connected, the video signals become more attenuated the further down the signal path the V-44SW or V-440HD is. When using identical video with three or more V-44SWs and/or V-440HDs, be sure to use a commercially available video multiplexer.

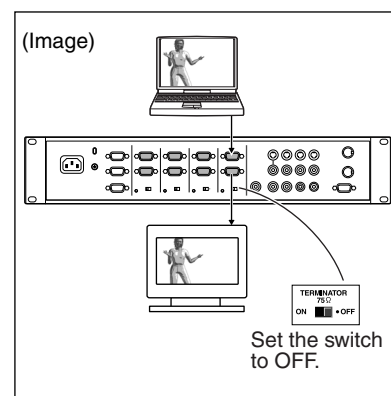

### About Connecting the Component Inputs and Outputs

You can use a D-sub to 5-BNC cable to connect the component inputs and outputs.

For more detailed information, refer to "About Connection Cables Used with the Component Inputs and Outputs" (p. 63).

### About the Ground Terminal

Depending on the circumstances of a particular setup, you may experience a discomforting sensation, or perceive that the surface feels gritty to the touch when you touch this device, microphones connected to it, or the metal portions of other objects, such as guitars. This is due to an infinitesimal electrical charge, which is absolutely harmless. However, if you are concerned about this, connect the ground terminal (see figure) with an external ground. When the unit is grounded, a slight hum may occur, depending on the particulars of your installation. If you are unsure of the connection method, contact the nearest EDIROL/Roland Service Center, or an authorized EDIROL/Roland distributor, as listed on the "Information" page.

Unsuitable places for connection

- Water pipes (may result in shock or electrocution)
- Gas pipes (may result in fire or explosion)
- Telephone-line ground or lightning rod (may be dangerous in the event of lightning)

### 3. Turn on the Power and Output the Video

- ① Turn on the power to the connected devices (with video devices, play back the video).
- ② Press the [POWER] switch at the right of the V-44SW's front panel to switch it to the ON position and turn on the power. (p. 26).
- ③ Press one of the OUTPUT FORMAT buttons [1080i], [720p], or [RGB] to select the output video format.
- ④ Press one of the SD VIDEO buttons [1]–[4] or one of the HD/RGB buttons [1]–[4] to select the input video.  
The video images appear in the display connected to the HD/RGB OUT PGM connector.

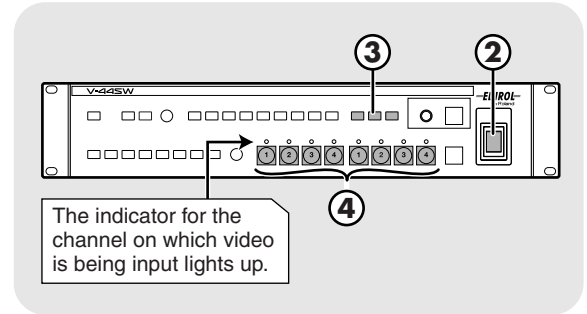

\* Switching of the video (procedures used) differ with the video switching mode. For more detailed information, refer to "Switching Video" (p. 36).

#### Working with the Menu p. 26

Output and input video image quality adjustments and other such settings are all made in the menus displayed. The menus appear in the television monitor connected to the MENU connector.

##### Displaying Menus and Selecting Parameters

Press the [MENU] button to display the Main menu.  
Use the [CURSOR/VALUE] knob to select a parameter.  
Press the [ENTER] button to confirm your choice.



Menu

##### Changing the Value of a Setting

Use the [CURSOR/VALUE] knob to change a value.

##### Closing Menus

Press [MENU] a number of times; menus close with each press of the button until the Main menu closes.

The content of the settings is saved to the V-44SW's internal memory the moment the Main menu is closed. Be sure to note that changes in the settings will not be saved if you turn off power before the Main menu is closed.

You can also have menus appear in the display showing the final video output.  
For more detailed information, refer to "If You Want to Display Menus in the Final Output Video" (p. 26).

#### Selecting the Output Format p. 35

Select the output format matching the specifications for the display used for showing the final output video.

The V-44SW is set at the factory to allow selection of the following formats with the OUTPUT FORMAT buttons.

##### Factory Settings

Button	Output Format	Output Connector
[1080i]	1080/60i	HD/RGB OUT PGM connectors 1, 2 HD/RGB OUT PREVIEW connector
[720p]	720/60p	
[RGB]	1024x768/60	

##### If You Want to Select a Different Output Format

You can change the output formats assigned to these buttons.

1. Press the [MENU] button to display the Main menu.
2. Select "1. Output" to display the sub-menu.
3. Select the name of the button whose setting you want to change with "1: Output Format (1080i) Sw"–"3: Output Format (RGB) Sw" in the sub-menu.
4. Set the output format.  
For more information on the output formats supported by the V-44SW, refer to "Compatible Output Formats" (p. 31).
5. Press the OUTPUT FORMAT button whose settings have been changed to change the output format.

#### If the video does not appear Please check the following points.

Have you set the proper output format?	Confirm the specifications for the display connected to the HD/RGB OUT PGM connector and reselect the output format.
Is the [OUTPUT FADE] button lit?	Press the [OUTPUT FADE] button so that the light goes off.
Have you selected a channel to which video is being input?	The indicators above SD VIDEO buttons [1]–[4] and HD/RGB buttons [1]–[4] light to indicate channels to which video is being input.
Is the video being played back by the video device?	Play back the video with the video device to input the video signals to the V-44SW.



## 4. Adjusting the Video Image Quality

### 4-1. Adjusting the Image Quality of the Final Output Video

 p. 30

① Press the [MENU] button to display the Main menu.

② Select “1. Output” to display the sub-menu.

Select the necessary parameters from the table below, then adjust the brightness, hue, and other such settings for the final output video.

#### ■ “1. Output” Sub Menu (Extract)

Zooming	Final output scaling adjustment
Bright	Final output brightness adjustment
Contrast	Final output contrast adjustment
Saturation	Final output saturation adjustment
Red	Final output red adjustment
Green	Final output green adjustment
Blue	Final output blue adjustment
Test Pattern Select	Selects the Test Pattern to output

#### ■ Test Pattern (Color Bar) Display

 p. 35

You can display a test pattern and use it in adjusting the brightness, image quality, hue, and other settings for the final output video.



Color Bar

1. Press the [MENU] button to display the Main menu.
2. Select “1. Output,” then select “14. Test Pattern Select” from the sub-menu.
3. Select “75% Color Bar” or “100% Color Bar”; the color bar is output.

### 4-2. Adjusting the Input Video Image Quality

 p. 32, 34

① Press the [MENU] button to display the Main menu.

② If you want to adjust the HD/RGB video input, select “3. HD/RGB Input”; if adjusting the SD video input, select “2. SD Input” (\*).

A sub-menu for selecting the channel for the HD/RGB input or SD input is displayed.

\* If adjusting the SD video image quality, first select “3. HD/RGB Input” from the sub-menu, then select “HD/RGB SD” and set the SD video input to the “HD/RGB section.” After this, proceed to set the SD input.

③ Select the input video channel to display the HD/RGB Ch or SD Ch sub-menu.

Select the necessary parameters from the table below, then adjust the brightness, hue, and other such settings for the input video.

#### ■ “HD/RGB SD, Ch1–4” Sub Menu (Extract)

Pre Scaling Mode	Switches scaling adjustment function
Manual Pre Scaling	Adjusts scaling ratio when full scaling used
Scaling Type	Selects the scaling method
Manual X Scale	Adjusts the horizontal expansion ratio
Manual Y Scale	Adjusts the vertical expansion ratio
X Position	Fine adjustment of the horizontal start position
Y Position	Fine adjustment of the vertical start position
Brightness	Brightness adjustment
Contrast	Contrast adjustment
Saturation	Saturation adjustment
Red	Red adjustment
Green	Green adjustment
Blue	Blue adjustment
Frequency *	Fine adjustment of the Sampling Frequency
Phase *	Fine adjustment of the Sampling Phase

\* Cannot be set with “HD/RGB SD.”

#### ■ “SD Ch1–4” Sub Menu (Extract)

SD InputSelect	Selects the SD input
SD Brightness	Brightness adjustment
SD Contrast	Contrast adjustment
SD Saturation	Saturation adjustment
SD Hue	Hue adjustment

## 5. Turning Off the Power and Quitting

① Turn off the power to the connected devices.

② Press the [POWER] switch at the right of the V-44SW’s front panel to switch it to the OFF position and turn off the power. ( p. 26).

## Examples for Connecting and Setting the V-44SW

### Outputting to a Plasma Display <HD Size (16:9) Output>

Use the V-44SW's component output for shows and other situations where the video is being output to plasma displays or high definition projectors

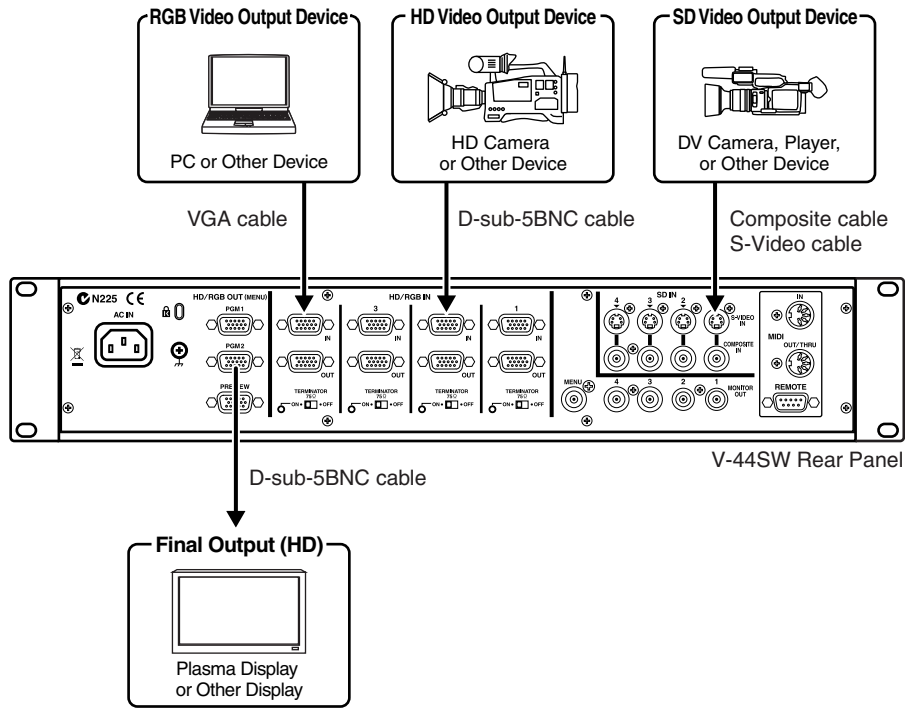

### V-44SW Settings

Make the following menu parameter settings. Set the parameters in accordance with your usage environment.

Settings Parameter	Value	See Page	
1. Output	1: Output Format (1080i) Sw, etc.	Selects optimal format, e.g., "1080i" or "720p", for the connected device.	p. 30
	5: Zooming	Set value to 100 or lower when entire screen is not being displayed, adjusting as you observe the screen being displayed.	
3. HD/RGB Input	3: Pre Scaling Mode	There are times when the RGB video is not displayed fully on the screen. Set the "3: Pre Scaling Mode" to "Manual," then adjust with the "4: Manual Pre Scaling" parameter.	p. 32
	4: Manual Pre Scaling		
	5: Scaling Type		
8. System	1: System Frame Rate	Select the format appropriate for the output device you are using.	p. 35

\* Menu parameter numbers in the "HD/RGB SD" sub-menu differ.

### Settings for Devices Other Than the V-44SW

The connected plasma display or hi-vision projector needs to be set up as follows.

Device	Setting
Plasma display, high-definition projector, or other display	Set the input to "Component Input."

## Outputting to a Projector <Live Output of RGB Video>

In business presentations and other such situations, use the V-44SW's RGB output when outputting video to a data projector.

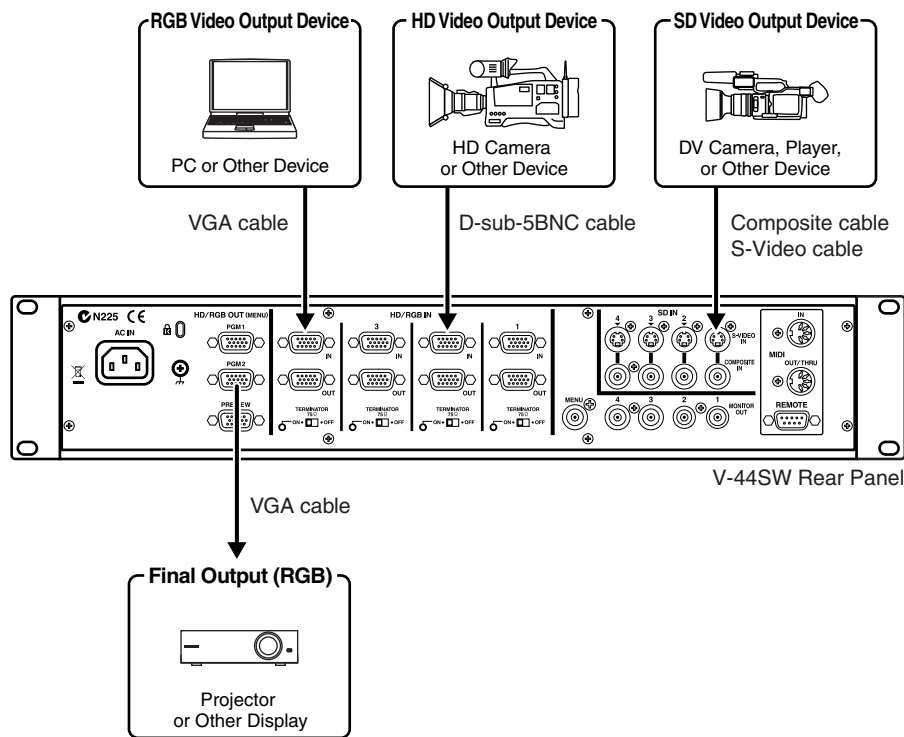

### V-44SW Settings

Make the following menu parameter settings. Set the parameters in accordance with your usage environment.

Settings Parameter	Value	See Page	
1. Output	3: Output Format (RGB) Sw, etc.	Selects optimal format, e.g., "1280 x 1024/60" to "640 x 480/60," for the connected device.	p. 30
	5: Zooming	Set value to 100 or lower when entire screen is not being displayed, adjusting as you observe the screen being displayed.	
3. HD/RGB Input	3: Pre Scaling Mode	There are times when excess video is displayed on the screen. In such cases, Set the "3: Pre Scaling Mode" to Manual, then adjust with the "4: Manual Pre Scaling" parameter.	p. 32
	4: Manual Pre Scaling		
	5: Scaling Type	As RGB or SD video features various differing aspect ratios, such as 4:3 and 16:9, it may be necessary to adjust the aspect ratio while observing the screen. If satisfactory results cannot be obtained with "Full Scale," "Fixed Aspect: Letter," or "Fixed Aspect: Crop," select "Manual." After selecting "Manual," adjusts the "6: Manual X Scale" and "7: Manual Y Scale" parameters.	
8. System	1: System Frame Rate	Select the format appropriate for the output device you are using.	p. 35

\* Menu parameter numbers in the "HD/RGB SD" sub-menu differ.

### Settings for Devices Other Than the V-44SW

The connected data projector or LCD display needs to be set up as follows.

Device	Setting
Data projector, computer-use liquid crystal display, or other display	Set the input to "RGB Input." Switch off if the screen features a 16:9 wide output function.

## Outputting to an LED Display <SD Size (4:3) Output>

In shows and other situations where SD video is being output to LED displays or similar displays, you can output video from the V-44SW's HD/RGB OUT PGM connectors.

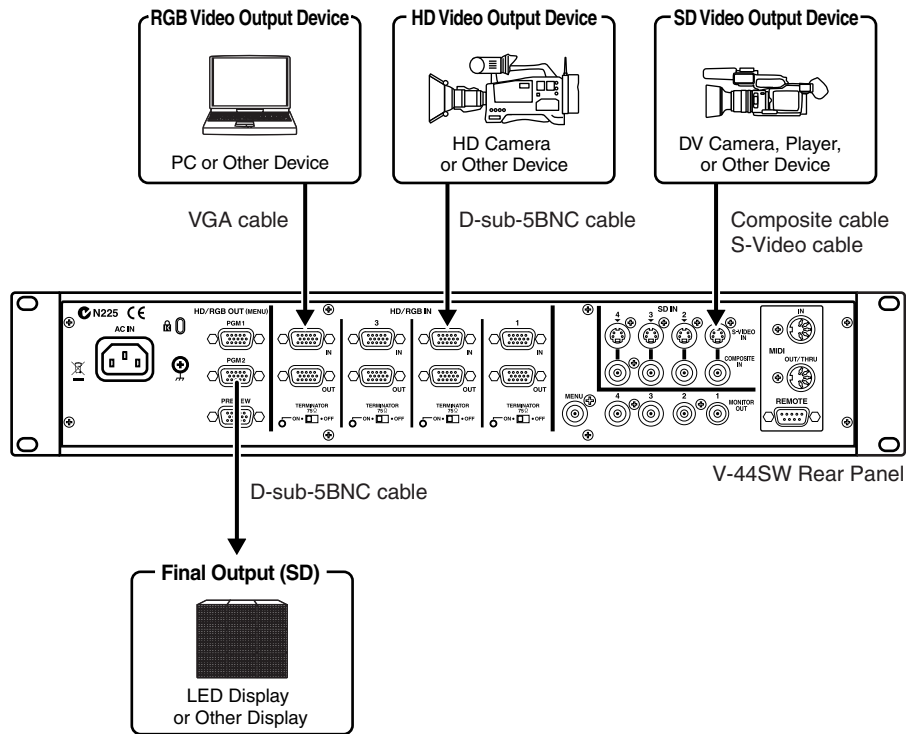

### V-44SW Settings

Make the following menu parameter settings. Set the parameters in accordance with your usage environment.

Settings Parameter	Value	See Page	
1. Output	1: Output Format (1080i) Sw, etc.	Selects optimal format, e.g., "480/60p" or "480/60i", for the output device. * When "1: System Frame Rate" below is set to 50-PAL, this parameter can be set to 576/50p or 576/50i.	p. 30
	3: Pre Scaling Mode	There are times when excess video is displayed on the screen. In such cases, Set the "3: Pre Scaling Mode" to Manual, then adjust with the "4: Manual Pre Scaling" parameter.	p. 32
3. HD/RGB Input	4: Manual Pre Scaling	There may be instances where the aspect ratio of video input with HD or RGB is not 4:3, it may be necessary to adjust the aspect ratio while observing the screen. If satisfactory results cannot be obtained with "Full Scale," "Fixed Aspect: Letter," or "Fixed Aspect: Crop," select "Manual." After selecting "Manual," adjusts the "6: Manual X Scale" and "7: Manual Y Scale" parameters.	
	5: Scaling Type		
	1: System Frame Rate	Select the format appropriate for the output device you are using.	p. 35

### Settings for Devices Other Than the V-44SW

The connected LED display needs to be set up as follows.

Device	Setting
LED display or other device	Set the input to "Component Input."

## Recording Hi-Vision Video to an HD Video Deck <HD-SDI Recording>

When recording the V-44SW's video output with an HD CAM deck, DVC PRO HD deck, HD non-linear editing device, or other such equipment, it may be necessary to convert the V-44SW's component output to HD-SDI signals. For this, you will need to obtain a separate HD HD-SDI converter to convert the component signals to HD-SDI.

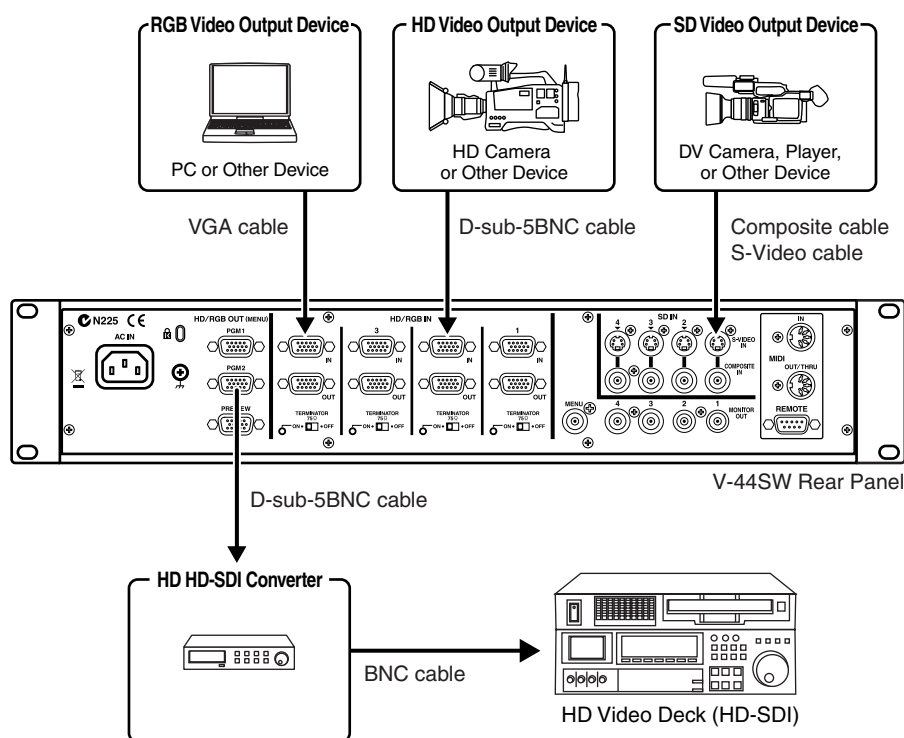

### V-44SW Settings

Make the following menu parameter settings. Set the parameters in accordance with your usage environment.

Settings Parameter	Value	See Page
1. Output	1: Output Format (1080i) Sw, etc.	Selects appropriate format for the HD-SDI converter being used.
	5: Zooming	Set to "100."
3. HD/RGB Input	3: Pre Scaling Mode	There are times when the RGB video is not displayed fully on the screen. Set the "3: Pre Scaling Mode" to "Manual," then adjust with the "4: Manual Pre Scaling" parameter.
	4: Manual Pre Scaling	
	5: Scaling Type	As RGB or SD video features various differing aspect ratios, such as 4:3 and 16:9, it may be necessary to adjust the aspect ratio while observing the screen. If satisfactory results cannot be obtained with "Full Scale," "Fixed Aspect: Letter," or "Fixed Aspect: Crop," select "Manual." After selecting "Manual," adjusts the "6: Manual X Scale" and "7: Manual Y Scale" parameters.
8. System	1: System Frame Rate	Select the format appropriate for the output device you are using.

\* Menu parameter numbers in the "HD/RGB SD" sub-menu differ.

### Settings for Devices Other Than the V-44SW

The connected hard disk recorder needs to be set up as follows.

Device	Setting
HD HD-SDI Converters	Sync Signal: Use internal sync signal (* Indications may vary with the device used.) Frame Rate: 59.94Hz
HD Recorder	Input Signal: HD-SDI signals Sync Signal: Use internal sync signal

# Quick Guide

## Try Outputting Some Video

When you have finished connecting and making the settings, try switching and outputting some video images. The method for switching video described in this section uses what is referred to as “Direct mode.” In addition to “Direct mode,” the V-44SW also features a “Preset mode” you can use for switching video.

☞ For more detailed operating instructions, refer to “Switching Video” (p. 36).

- 1 Turn on the power to the connected devices (with video devices, play back the video).**
- 2 Press the [POWER] switch at the right of the V-44SW’s front panel to switch it to the ON position and turn on the power. (☞ p. 26).**

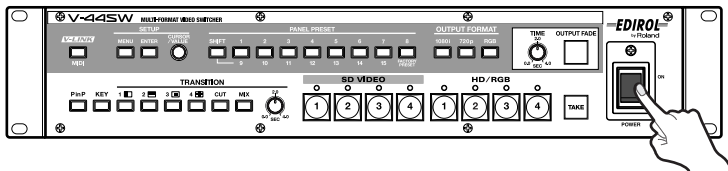

- 3 Press one of the SD VIDEO buttons [1]–[4] or HD/RGB buttons [1]–[4] to select the input video.**

The selected button lights up, and the video appears in the display connected to the HD/RGB OUT PGM connector.

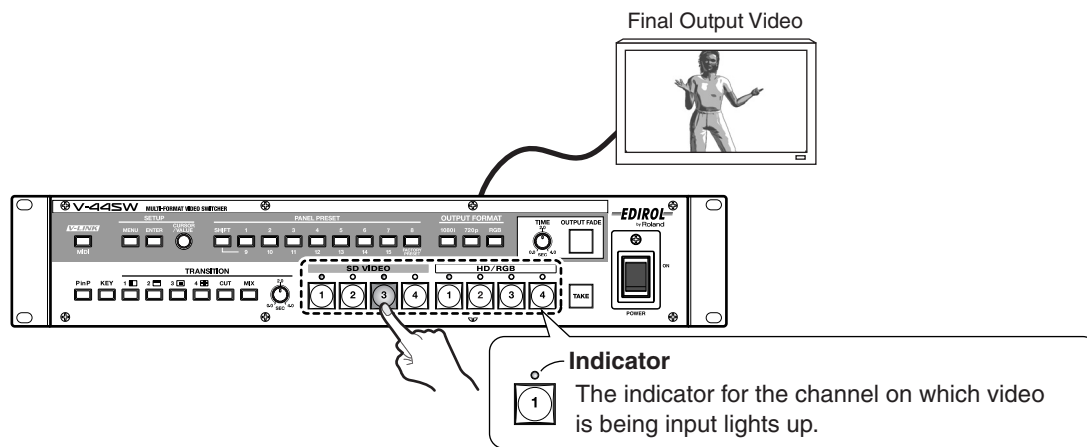

- 4 Repeating Step 3, now try your hand at switching the video images.**
- 5 When you are finished, first turn off the power to the connected devices. After this, press the [POWER] switch at the right of the V-44SW’s front panel to switch it to the OFF position and turn off the power (☞ p. 26).**

# Try Adding Some Screen Transition Effects

The V-44SW features a selection of screen transition effects, including six types of wipe effects as well as cut and mix effects. Now try changing the screen transition effects to switch the video in various different ways.

For more detailed operating instructions, refer to “Selecting the Effects To Be Applied in Switching” (p. 38).

## 1 Press a TRANSITION selection button to select the screen transition effect.

The selected button lights up. Now try switching the video to confirm the effect.

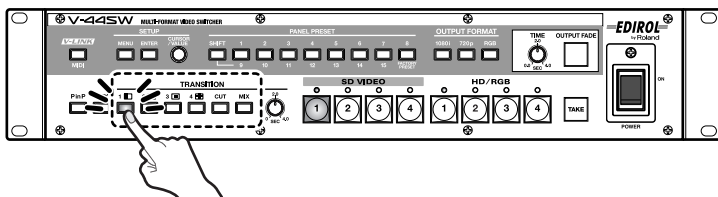

Button	Effect Name	Explanation	
[1 □]	Wipe	The current video is replaced as the subsequent video spreads across the screen.	A → A → B
[2 ▢]			A → R → B
[3 ▣]			A → B → B
[4 ▤]			A → E → B
[CUT]	Cut	The video is switched instantly.	
[MIX]	Mix	The previous video gradually fades out while the ensuing video image gradually fades in over it, until the new video is fully visible.	A → A → B

## 2 Using the [TRANSITION TIME] knob, set the amount of time it's to take for the videos to switch.

If a wipe or mix effect is selected, you can set the time used for switching the video to any value from 0.0 to 4.0 seconds. Try adjusting this setting until the video is switched with the timing you want.

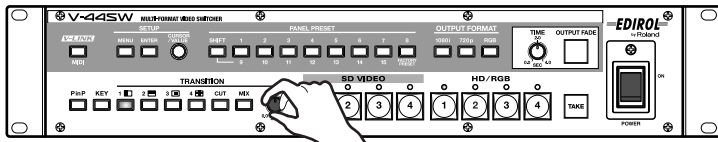





# Operation Guide

# Basic Operation

## Turning the Power On

- This unit is equipped with a protection circuit. A brief interval (a few seconds) after power up is required before the unit will operate normally.

- 1 Confirm that all other devices are properly connected.
- 2 Switch the [POWER] switch at the right of the V-44SW's front panel to ON.

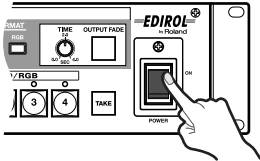

## Turning the Power Off

- When changing settings using the menu operations (p. 27), be sure to close the Main menu before turning off the power. The content of the settings will not be saved if the power is turned off without the Main menu being closed.

- 1 Turn off the power to the connected devices.
- 2 Switch the [POWER] switch at the right of the V-44SW's front panel to OFF.

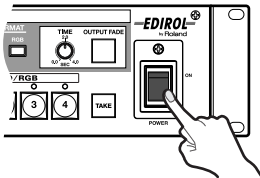

- If you need to turn off the power completely, first turn off the POWER switch, then unplug the power cord from the power outlet. Refer to "Power Supply" (p. 8).

## Setting the Various Functions (Menu)

Video brightness and contrast adjustments and a variety of other settings for the V-44SW are made by displaying menus and making the settings with these menus.

Menus include the Main menu and sub-menus. For more detailed information on the parameters, refer to the "Menu List" (p. 54).

### Getting Ready to Display Menus

Menus are displayed in the television monitor connected to the MENU connector. Set up the television monitor used for displaying the menus.

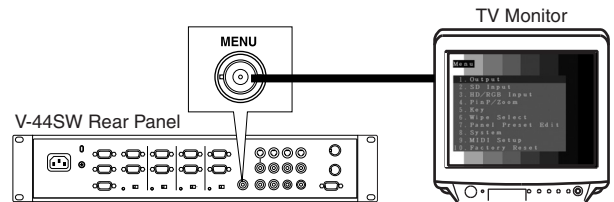

\* Background picture for the Menu is in black and white.

## If You Want to Display Menus in the Final Output Video

You can display menus in the final output video.

- 1 Hold down the [SHIFT] button and press the [MENU] button.

After this, display of menus in the video output from the HD/RGB OUT PGM and the HD/RGB OUT PREVIEW connectors is enabled.

- The size of the menu displayed may differ depending on the output settings (p. 30).
- This procedure is a shortcut for switching on and off the "6: HD/RGB On Screen Display" function in "8. System." Each time the [MENU] button is pressed while the [SHIFT] button is held down, display of the menu from the "HD/RGB OUT PGM connector and HD/RGB OUT PREVIEW connector" is alternately turned on and off.

## About Menu Levels

Menus are arranged as shown in the figure below. The values are set in the lowest level in each respective parameter.

Main menu		
1.	Output	
	Sub-menu	Value
	1: Output Format (1080i) Sw	1280x1024, 1280x768, .....
	2: Output Format (720p) Sw	1280x1024, 1280x768, .....
	3: Output Format (RGB) Sw	1280x1024, 1280x768, .....
	4: Output Format Sw Lock	Off, On
	⋮	⋮
2.	SD Input	
	⋮	⋮

## ■ Working with the Menus

### Displaying Menus and Selecting Parameters

- 1 Press the [MENU] button to display the Main menu.



- 2 Use the [CURSOR/VALUE] knob to select a parameter.

Rotating the [CURSOR/VALUE] knob moves the cursor vertically on the screen. The parameter where the cursor is located flashes, indicating that this parameter is selected.

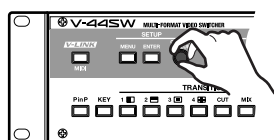

- 3 Press the [ENTER] button to confirm your choice.

Once the menu parameter selection has thus been confirmed, the V-44SW advances to the next (lower level) menu.

The [ENTER] button is also pressed to respond “Yes” to messages appearing on the screen during menu operations.



- Press the [MENU] button to go back to the immediately preceding menu (the next level above).

### Changing the Value of a Setting

- 1 Use the [CURSOR/VALUE] knob to change a value.  
If the cursor is located at the value set for a parameter in the menu, rotating the knob will change the value.

### Closing Menus

- 1 Press [MENU] a number of times; menus close with each press of the button until the Main menu closes.

### Saving the Settings

The content of the settings is saved to the V-44SW's internal memory the moment the Main menu is closed.

Be sure to note that changes in the settings will not be saved if you turn off power before the Main menu is closed.

### Locking Out Menu Operations

You can disallow changes in settings by selecting “8. System” from the menu and setting “11: Memory Protect” to “On.”

## ■ Menu Display Shortcuts

You can use menu display shortcuts, easily opening sub-menus assigned to the buttons.

Shortcut Operation	Sub Menu Displayed
[MENU] + [1080i]	1. Output (p. 54) * Cursor positioned at “1: Output Format (1080i) Sw”
[MENU] + [720p]	1. Output p. 54) * Cursor positioned at “2: Output Format (720p) Sw”
[MENU] + [RGB]	1. Output (p. 54) * Cursor positioned at “3: Output Format (RGB) Sw”
[MENU] + [OUTPUT FADE]	1. Output (p. 54*) * Cursor positioned at “12: Output Fade Mode”
[MENU] + SD VIDEO [1]–[4]	2. SD Input → SD Ch1–4 (p. 55)
[MENU] + HD/RGB [1]–[4]	3. HD/RGB Input → HD/RGB Ch1–4 (p. 55)
[MENU] + [P in P]	4. P in P/Zoom (p. 56)
[MENU] + [KEY]	5. Key (p. 56)
[MENU] + WIPE [1]–[4]	6. Wipe Select → Wipe Sw1–4 (p. 57)

## Fading Out the Final Output

You can fade out the final output. This convenient function allows you to output black (or white) video when useful, such as during pauses for standby and at the ends of presentations.

### 1 Set the fade time with the [TIME] knob.

You can set the fade time to any value from 0.0 to 4.0 seconds.

If you want to cut instantly to black (or white), set the time to “0.0” (seconds).

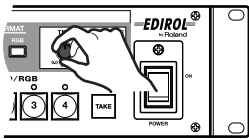

### 2 Press the [OUTPUT FADE] button to fade out the final output.

The video fades out over the time set in Step 1.

To have the video fade in again, press the [OUTPUT FADE] button once more.

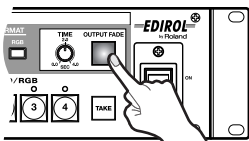

- You can confirm the status of fadeouts and fade-ins by checking the [OUTPUT FADE] button.

[OUTPUT FADE] Button	Video Output Status
Flashing	Video currently fading out or in
Lit	Black (or white) video currently output
Off	Normal output

- Pressing the (flashing) [OUTPUT FADE] button again while the video is fading out stops the fadeout at the point the button is pressed. When the [OUTPUT FADE] button is pressed once more, the fadeout resumes.

This procedure also works in the same fashion with fade ins.

## Changing the Fade Color

### 1 Press the [MENU] button to display the Main menu.

### 2 Select “1. Output” and select “13: Output Fade Color” from the sub-menu.

### 3 Set the parameter to “Black” or “White.”

## Using the [TIME] Knob to Fade Out the Video

You can fade the final output in and out manually with the [TIME] knob.

### 1 Press the [MENU] button to display the Main menu.

### 2 Select “1. Output” and select “12: Output Fade Mode” from the sub-menu.

### 3 Set the parameter to “Manual.”

Following this, you can use the [TIME] knob to control the fading in and out of the final output

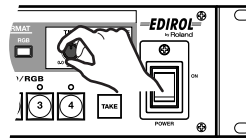

- The [OUTPUT FADE] button will not function when pressed at this time. Only the fade status is indicated (flashing/lit/off).

[TIME] Knob	[OUTPUT FADE] Button	Video Output Status
(0.0 sec.)	Lit	Black (or white) video currently output
(0.0 - 4.0)	Flashing	Video currently fading out or in
(4.0 sec.)	Off	Normal output

## Restoring the Original Factory Default Settings (Factory Reset)

You can return the content of the settings to their original status at the time the V-44SW shipped from the factory.

Try running Factory Reset when the V-44SW functions differently than described in the Owner's Manual, even though you've carried out the procedures according to the instructions.

### NOTE

- **When Factory Reset is executed, except for the two parameters below, the content of all settings made up to that point is lost when Factory Reset is executed.**

\* The current settings for the two "8. System" parameters "1: System Frame Rate" and "12: V-440HD Slave Mode" remain unchanged.

## Restoring All Settings to the Original Factory Default Setting

- 1 Press the [MENU] button to display the Main menu.
- 2 Select "10. Factory Reset."
- 3 The message "Are You Sure?" appears; select "Yes."
- 4 Press the [ENTER] button.  
This executes Factory Reset.

## Restoring the Original Factory Default Settings in Individual Sub-Menus

You can also execute Factory Reset for individual sub-menus. To do this, select the "Reset" option from within the sub-menu.

The following describes an example with instructions for Factory Reset with the "1. Output" sub-menu.

- 1 Press the [MENU] button to display the Main menu.
- 2 Select "1. Output" and select "15: Output Reset" from the sub-menu.
- 3 Select "Yes."
- 4 Press the [ENTER] button.  
This executes Factory Reset for the "1. Output" sub-menu.

# Setting the Input and Output

The V-44SW handles input and output video in differing video formats, thus requiring adjustment of the image quality and field of view for each format.

Appropriate settings need to be made for the input and output, to accommodate both the device that will be supplying the input to the V-44SW and the device to which the V-44SW will be outputting video.

- Confirm the settings for the input and output by checking the output video as you make the settings.

## Start by making settings for the output.

Settings determining image quality, such as those for the brightness, hue, and contrast, need to be made for both the input and output. However, when adjusting image quality, you should begin by making settings for the output, so they serve as a reference point for other adjustments.

If you adjust the image quality of the input first, then change the output settings later on, the video's colors and field of view will end up differing from those at the time the input settings were made.

## Setting the Output

### ■ Setting the Output Format

- 1 Press one of the **OUTPUT FORMAT** buttons [**1080i**], [**720p**], or [**RGB**] to select the output video format.

Select the output format matching the specifications of the display you are using to display the final video output.

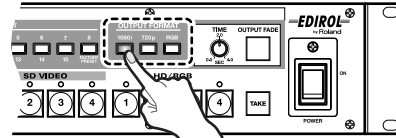

The V-44SW is set at the factory to allow selection of the following formats with the **OUTPUT FORMAT** buttons.

#### <Factory Settings>

Button	Output Format	Output Connector
[1080i]	1080/60i	HD/RGB OUT PGM connectors 1, 2
[720p]	720/60p	HD/RGB OUT PREVIEW connector
[RGB]	1024x768/60	

If selecting a different output format, follow the instructions in “Changing the Output Format” to change the output format for each **OUTPUT FORMAT** button.

### Changing the Output Format

You can change the output formats assigned to each **OUTPUT FORMAT** button.

- 1 Press the [**MENU**] button to display the Main menu.
- 2 Select “1. Output” then select the name of the button whose setting you want to change with “1: Output Format (1080i) Sw”–“3: Output Format (RGB) Sw” in the sub-menu.
- 3 Set the output format.  
For more on output formats, refer to “Compatible Output Formats” (p. 31).

## Compatible Output Formats

### <Component>

Frame Rate 60 (NTSC)	Frame Rate 50 (PAL)
1080/60i	1080/50i
720/60p	720/50p
480/60p	576/50p
480/60i	576/50i

- The component format settings include “60” and “50” frame rate settings. The general frame rate setting for Japan and the United States (NTSC) is “60” frames per second; the general setting in Europe (PAL) is “50.”

For instructions on switching the frame rate, refer to “Selecting NTSC or PAL Format” (p. 35).

### <RGB>

1366x768/75	1280x768/75	800x600/75
1366x768/60	1280x768/60	800x600/60
1280x1024/60	1024x768/75	640x480/75
	1024x768/60	640x480/60

\* Units: horizontal (pixels) x vertical (lines) / frame rate (Hertz)

## Preventing Errors in Switching the Output Format

To prevent the output format from being switched accidentally, disable switching so that the output format is not switched even when the OUTPUT FORMAT buttons are pressed.

### 1 Press the [MENU] button to display the Main menu.

### 2 Select “1. Output” and select “4: Output Format Sw Lock” from the sub-menu.

### 3 Set the parameter to “On.”

Afterwards, the V-44SW will be unable to switch the output format even when the OUTPUT FORMAT buttons are pressed.

## Setting the Output

### 1 Press the [MENU] button to display the Main menu.

### 2 Select “1. Output.”

You can make changes to the following parameters.

1. Output Sub Menu (p. 54)	
1: Output Format (1080i) Sw	Output format assigned to OUTPUT FORMAT [1080i] button
2: Output Format (720p) Sw	Output format assigned to OUTPUT FORMAT [720p] button
3: Output Format (RGB) Sw	Output format assigned to OUTPUT FORMAT [RGB] button
4: Output Format Sw Lock	OUTPUT FORMAT button lock
5: Zooming	Final output scaling adjustment
6: Bright	Final output brightness adjustment
7: Contrast	Final output contrast adjustment
8: Saturation	Final output saturation adjustment
9: Red	Final output red adjustment
10: Green	Final output green adjustment
11: Blue	Final output blue adjustment
12: Output Fade Mode	Final output fade control adjustment For more detailed information, refer to “Using the [TIME] Knob to Fade Out the Video” (p. 28).
13: Output Fade Color	Final output fade color setting For more detailed information, refer to “Changing the Fade Color” (p. 28).
14: Test Pattern Select	Selects the Test Pattern to output For more detailed information, refer to “Displaying a Test Pattern” (p. 35).
15: Output Reset	The sub-menu settings are returned to their factory default settings (p. 29).

## About Delaying the Output

Note that, due to the process of up-converting and down-converting processes, the use of multiple formats with the V-44SW will result in a lag of several frames.

<Approximate Delays>

Input connectors	Number of Frames Delayed
SD IN connectors	2 frames
HD/RGB IN connectors	1 frames

These delays may cause discrepancies in the timing of the external audio and the video processed by the V-44SW.

In such a case you might use an audio delay line in order to synchronize the video and audio.

## Setting the HD/RGB Input

With HD/RGB video, since the field of view and color may vary according to the format and device, be sure to make these settings for each input

- 1 Press the [MENU] button to display the Main menu.
- 2 Select “3. HD/RGB Input” and then select the channel you want to set with “1: HD/RGB SD”–“5: HD/RGB Ch4” in the sub-menu.

- To set SD video input to the “HD/RGB section,” select “1: HD/RGB SD.”

You can make changes to the following parameters.

2. HD/RGB Input → HD/RGB SD, Ch Sub Menu (☞ p. 55)	
1: Format Auto Detect *1 *2	Function automatically distinguishes input Auto: The input format is determined automatically. Manual: The input format is selected in accordance with “2: Input Format.”
2: Input Format *1 *2	Selects input format
3: Pre Scaling Mode	Switches scaling adjustment function Auto: The scaling is adjusted automatically. Manual: The scaling is adjusted in accordance with “4: Manual Pre Scaling.”
4: Manual Pre Scaling *3	Adjusts scaling ratio when full scaling used This setting has no effect in the P in P effect (p. 39) sub-screen.
5: Scaling Type	Selects the scaling method For more detailed information, refer to “About the Scaling Type” (p. 33)
6: Manual X Scale *4	Adjusts the horizontal expansion ratio
7: Manual Y Scale *4	Adjusts the vertical expansion ratio
8: X Position	Fine adjustment of the horizontal start position
9: Y Position	Fine adjustment of the vertical start position
10: Brightness	Brightness adjustment
11: Contrast	Contrast adjustment
12: Saturation	Saturation adjustment
13: Red	Red adjustment
14: Green	Green adjustment
15: Blue	Blue adjustment
16: Frequency *1	Fine adjustment of the Sampling Frequency
17: Phase *1	Fine adjustment of the Sampling Phase
18: Sw Enable *1	Sets the Enable/Disable status for the channel select buttons For more detailed information, refer to the column, “To Prevent Errors in Using the Channel Select Buttons” (p. 37).
19: Input Ch Reset	The sub-menu settings are returned to their factory default settings (☞ p. 29).

\*1 Cannot be set in HD/RGB SD. Parameter numbers are in sequence, with these parameters omitted.

\*2 Enabled when Format Auto Detect is set to Manual.

\*3 Enabled when Pre Scaling Mode is set to Manual.

\*4 Enabled when Scaling Type is set to Manual.

### HD Signals: Compatible Input Formats

1080 59.94i / 50i: (SMPTE 274M)
720 59.94p / 50p: (SMPTE 296M)

### RGB Signals: Compatible Input Formats

640x480/60	800x600/75	1280x768/60
640x480/75	1024x768/60	1280x768/75
800x600/60	1024x768/75	1280x1024/60

\* Units: horizontal (pixels) x vertical (lines) / frame rate (Hertz)

\* Certain signal conditions may produce differences in the aspect ratio and position of the RGB input. If this occurs, make adjustments with the “8: X position,” “9: Y position,” “16: Frequency,” “17: Phase” or other relevant settings from the menu.

### Automatically Setting the RGB Input

You can have the V-44SW automatically determine the RGB input signals and change the settings automatically to match these input signals.

- 1 While holding down the [SHIFT] button, for at least three seconds hold down the HD/RGB button [1]–[4] corresponding to the channel to which the RGB signals are being input.

Once the automatic settings are completed, all of the HD/RGB 1–4 indicators flash.

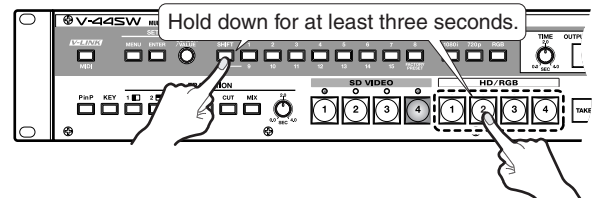



### About the Scaling Type

You can scale (enlarge or reduce) input video with a different aspect ratio (the ratio of the screen's vertical and horizontal dimensions) to match that of the output format (p. 30) to have the video appear in the proper aspect ratio.

Values	Explanation	Input		Output	
<b>Full Scale</b>	The aspect ratio of the input video is automatically adjusted to conform to the output aspect ratio, with the images displayed in the entire screen	4:3 NTSC / 480i PAL / 576i, 1024 x 768 800 x 600, 640 x 480		→	
		4:3 (Letterbox) NTSC / 480i PAL / 576i		→	
		4:3 (Squeeze) NTSC / 480i PAL / 576i		→	
		16:9 1080i 720p		→	
<b>Fixed Aspect: Letter</b>	The aspect ratio of the input video is maintained, and the images are sized to fit within the screen.  Black matte video appears in parts of the screen not occupied by the video image.	4:3, NTSC / 480i PAL / 576i, 1024 x 768 800 x 600, 640 x 480		→	
		4:3 (Letterbox) NTSC / 480i PAL / 576i		→	
		4:3 (Squeeze) NTSC / 480i PAL / 576i		→	
		16:9 1080i 720p		→	
<b>Fixed Aspect: Crop</b>	The aspect ratio of the input video is maintained, and the images are sized to fit within the screen.  * If the aspect ratio of the input video differs from the output aspect ratio, a portion of the video image is cropped, and the cropped portion is not displayed.	4:3, NTSC / 480i PAL / 576i, 1024 x 768 800 x 600, 640 x 480		→	
		4:3 (Letterbox) NTSC / 480i PAL / 576i		→	
		4:3 (Squeeze) NTSC / 480i PAL / 576i		→	
		16:9 1080i 720p		→	
<b>Manual</b>	If you are unable to achieve a suitable aspect ratio using "Full Scale," "Fixed Aspect: Letter," or "Fixed Aspect: Crop," select "Manual" and adjust the aspect ratio manually.  After selecting "Manual," adjust the following menu options. "6: Manual X Scale" "7: Manual Y Scale" : Vertical and horizontal dimensions "8: X Position" "9: Y Position" : Position				

## Setting the SD Input

With SD video, there can be individual differences depending on the type of device, so settings for the input should be made individually.

SD signals are input to the “SD section” then pass through the “HD/RGB section” before being output (p. 9). Thus, the two following types of settings are required in adjusting the SD video.

- ① Settings for the SD video input to the “HD/RGB section”
  - ☞ “Setting the HD/RGB Input” (p. 32)
- ② Settings for the SD video input to the “SD section”
  - ☞ Settings in this section

\* Make the settings for ① before the settings in ②.

- 1 Press the [MENU] button to display the Main menu.
- 2 Select “2. SD Input” and then select the channel you want to set with “1: SD Ch1”–“4: SD Ch4” in the sub-menu.

You can make changes to the following parameters.

2. SD Input → SD Ch Sub Menu (☞ p. 55)	
1: SD Input Select	Selects the SD input Auto: The connector used for the SD signals being input is selected automatically. If SD signals are being input to both connectors on the same channel, the S-VIDEO IN connector is selected. S-Video: Only the input from the S-VIDEO IN connector is selected. Composite: Only the input from the COMPOSITE IN connector is selected.
2: SD Brightness	Brightness adjustment
3: SD Contrast	Contrast adjustment
4: SD Saturation	Saturation adjustment
5: SD Hue	Hue adjustment
6: SD Sw Enable	Sets the Enable/Disable status for the channel select buttons For more detailed information, refer to the column, “To Prevent Errors in Using the Channel Select Buttons” (p. 37).
7: SD Reset	The sub-menu settings are returned to their factory default settings (☞ p. 29).

## SD Signals: Compatible Input Formats

NTSC	59.94Hz	Composite video format
		S-Video format
PAL	50Hz	Composite video format
		S-Video format

- It may be necessary to change the V-44SW’s input and output formats to match the video signals (NTSC or PAL) being input. For instructions on switching the input and output formats, refer to “Selecting NTSC or PAL Format” (p. 35).

## If the Video is Disrupted

There may be instances in which the level of the synchronization signal output by the SD video device is lower than the standard value, with disruption of the video resulting from the poor synchronization.

In such instances, select “8. System” in the menu and adjust the value in “3: SD Input Sync Threshold.” You may be able to synchronize the video and have it display properly.

## Selecting NTSC or PAL Format

The V-44SW's input and output formats are selectable; you can specify the NTSC format used in Japan and the United States or the PAL format used in Europe. Switch to the format suited to your needs.

- Switching the input and output formats also switches the frame rate of the output format of component (p. 31).

With NTSC format: Frame rate of "60" frames per second

With PAL format: Frame rate of "50" frames per second



- 1 Press the [MENU] button to display the Main menu.
- 2 Select "8. System" and select "1: System Frame Rate" from the sub-menu.
- 3 Set each parameter to "60-NTSC" or "50-PAL."  
60-NTSC: NTSC format  
50-PAL: PAL format

## Displaying a Test Pattern

You can display a test pattern (color bars), useful and convenient in adjusting the image quality of the display.

- 1 Press the [MENU] button to display the Main menu.
- 2 Select "1. Output" and select "14: Test Pattern Select" from the sub-menu.
- 3 Select the test pattern to be displayed.

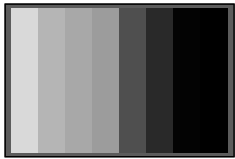
The test pattern (color bars) is output.

Value	Displayed
Off	(No output)
75% Color Bar	
100% Color Bar	

# Switching Video

## Selecting the Video Switching Mode

The V-44SW features two different video switching modes, “Direct mode” and “Preset mode.”

Each mode functions in switching video as follows.

### Direct Mode

The final output video is switched when channels are selected with the press of a single button.

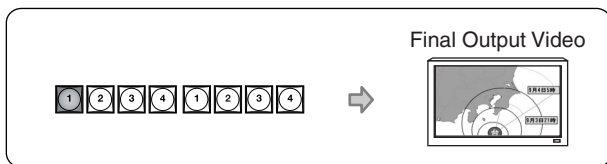

### Preset Mode

When a channel is selected, the video in the preview monitor switches. Pressing the [TAKE] button confirms selection of this as the output video, switching the final output video.

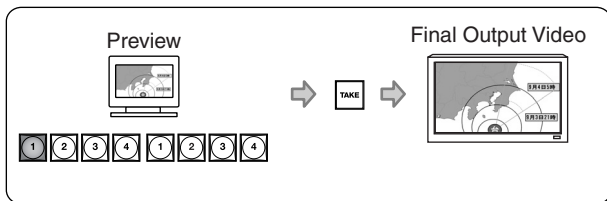

## Selecting the Video Switching Mode

- 1 Press the [MENU] button to display the Main menu.
- 2 Select “8. System” and select “7: Panel Operation Mode” from the sub-menu.
- 3 Select “Direct Mode” or “Preset Mode.”  
Direct Mode: video is switched in Direct mode.  
Preset Mode: video is switched in Preset mode.

### About the Effects Used in Switching Screens

You can apply the screen transition effects, regardless of the mode used for switching the video.

For more detailed instructions, refer to “Selecting the Effects To Be Applied in Switching” (p. 38).

## Switching Video in Direct Mode

- Immediately after the power is turned on, SD VIDEO Channel 1 is assigned as the final output.

- 1 Press one of the SD VIDEO buttons [1]–[4] or one of the HD/RGB buttons [1]–[4] to select the channel.

The selected button lights up, and the final output video is switched.

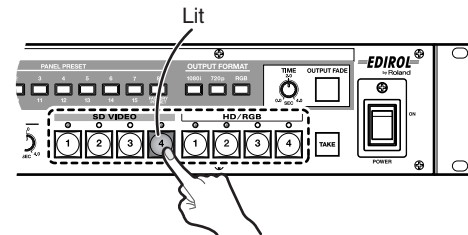

- Selecting an HD/RGB channel to which no signals are input may result in delayed switching of the video.

### About the Indicators



Whenever video is being input to a channel, its indicator lights up. You can determine the type of video signal being input by observing the color of the indicator.

Indicator	SD VIDEO1–4	HD/RGB1–4
Lit (Red)	Composite signal	RGB signal
Lit (Green)	S-video signal	Component signal
Lit (Green)	No signal input	No signal input

### About the Colors of Channel Select Buttons



You can change the colors in which channel select buttons light.

- 1 Press the [MENU] button to display the Main menu.
- 2 Select “8. System” and select “8: Input Sw LED Color” from the sub-menu.
- 3 Select the colors for the channel select buttons.

- “Sub” refers to the colors in which LEDs light when video is selected in the Picture in Picture sub-screen (p. 39) and with the key composite effects (p. 41).

Value	Color	
	Main	Sub
Main=YEL : Sub=GRN	Yellow	Green
Main=YEL : Sub=RED	Yellow	Red
Main=RED : Sub=GRN	Red	Green
Main=RED : Sub=YEL	Red	Yellow
Main=GRN : Sub=RED	Green	Red
Main=GRN : Sub=YEL	Green	Yellow

## Switching in Preset Mode

- Immediately after the power is turned on, SD VIDEO Channel 1 is assigned as the final output.

### 1 Press one of the SD VIDEO buttons [1]–[4] or one of the HD/RGB buttons [1]–[4] to select the channel.

The selected button flashes, and the input video appears in the preview monitor connected to the HD/RGB OUT PREVIEW connector.

- The final output video is not switched at this stage. Select the video you want to use as the final output while checking the video being input.
- The channel select button corresponding to the previewed video flashes.

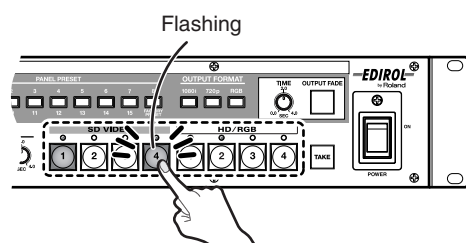

- Selecting an HD/RGB channel to which no signals are input may result in delayed switching of the video.

### 2 Once you decide to use the video, press the [TAKE] button.

The video shown in the preview monitor is output as the final output video, and this video appears in the display connected to the HD/RGB OUT PGM connector.

- The channel select button for the video output as the final output video remains lit.

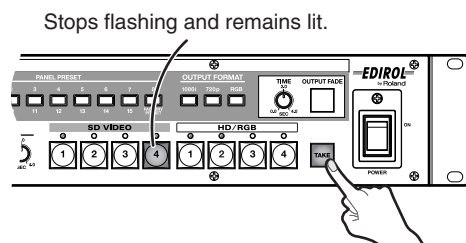

### 3 Repeat Steps 1 and 2 to switch the video images.

## To Prevent Errors in Using the Channel Select Buttons

You can disable the operation of channel select buttons you are not using. This is useful in preventing accidental output of video.

### SD VIDEO Buttons [1]–[4]

- 1 Press the [MENU] button to display the Main menu.
- 2 Select “2. SD Input” and select “1: SD Ch1” – “4: SD Ch4” from the sub-menu to specify the channel you want to set.
- 3 Select “6: SD Sw Enable” from the SD Ch sub-menu.
- 4 Set this to “Off.”  
Once set, the button will not function even when pressed.

### HD/RGB Buttons [1]–[4]

- 1 Press the [MENU] button to display the Main menu.
- 2 Select “3. HD/RGB Input” and select “2: HD/RGB Ch1” – “5: HD/RGB Ch4” from the sub-menu to specify the channel you want to set.
- 3 Select “18: Sw Enable” from the HD/RGB Ch sub-menu.
- 4 Set this to “Off.”  
Once set, the button will not function even when pressed.

## Selecting the Effects To Be Applied in Switching

The V-44SW features a selection of screen transition effects, including six types of wipe effects as well as cut and mix effects.

### 1 Press a TRANSITION selection button to select the screen transition effect.

The selected button lights up.

For more details on effects, refer to the table “TRANSITION Selection Buttons and Effects” below.

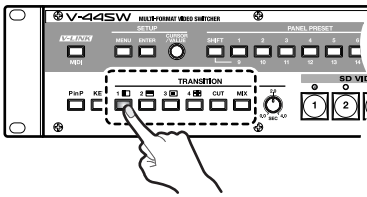

### 2 Use the [TRANSITION TIME] knob to set the time used in switching the video.

If a wipe or mix effect is selected, you can set the video transition time to any value from 0.0 to 4.0 seconds. Try adjusting this setting until the video is switched with the timing you want.

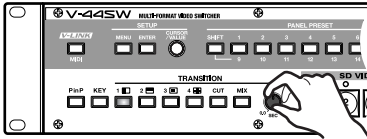

## ■ Customizing Wipe Transitions

You can change the WIPE button’s settings, including settings for the wipe pattern and soft edge, allowing you to customize your wipe transition.

### 1 Press the [MENU] button to display the Main menu.

### 2 Select “6. Wipe Select” and specify the WIPE button whose settings you want to change by selecting “1: Wipe Sw1”–“4: Wipe Sw4” from the sub-menu.

You can make changes to the following parameters.

6. Wipe Select → Wipe Sw Sub Menu (p. 57)	
1: Wipe Pattern	Wipe pattern setting Horizontal Vertical Horizontal Open Vertical Open Box Cross
2: Wipe Reverse	Setting this to “On” reverses the direction of the wipe.
3: Wipe Edge Type	Soft Edge Type setting Hard: Gives the video a straight, distinct edge. Soft: Gives the video a soft, fading edge.
4: Key Reset	The sub-menu settings are returned to their factory default settings (p. 29).

## TRANSITION Selection Buttons and Effects

Button	Effect Name	Explanation	
[1 ▣]	Wipe	The current video is replaced as the subsequent video spreads across the screen.	
[2 ▢]			
[3 ▣]			
[4 ▢]			
[CUT]	Cut	The video is switched instantly.	
[MIX]	Mix	The previous video gradually fades out while the ensuing video image gradually fades in over it, until the new video is fully visible.	

### About the Wipe Patterns

- You cannot select the WIPE [1 ▣]–[4 ▢] buttons when using the Picture in Picture effect. If you press the [P in P] button while a WIPE [1 ▣]–[4 ▢] button is selected, the V-44SW automatically switches to the [MIX] button.
- The wipe patterns listed in the table above are the factory default settings. You can change the wipe pattern, soft edge, and other settings for each WIPE button individually. For more detailed information, refer to “Customizing Wipe Transitions.”

# Adding Effects to the Video

You can add effects that combine two different video images.

## Adding the Picture in Picture (P in P) Effect

With this effect, the video in the channel to which the Picture in Picture (P in P) effect is applied is sent to the sub-screen, which appears in reduced size within the video on another channel (the background screen).

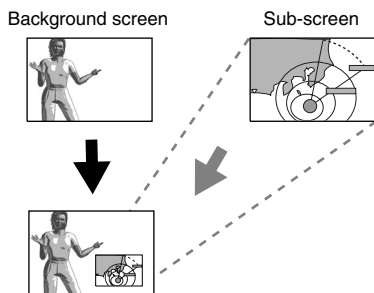

### Terminology Used with the P in P Effect

The following terminology is used in describing the V-44SW's P in P effect.

- **Position:** positioning of the sub-screen
- **Size:** size of the sub-screen
- **Zoom:** Magnification of the video in the sub-screen
- **Pan:** Positioning of the video within the sub-screen

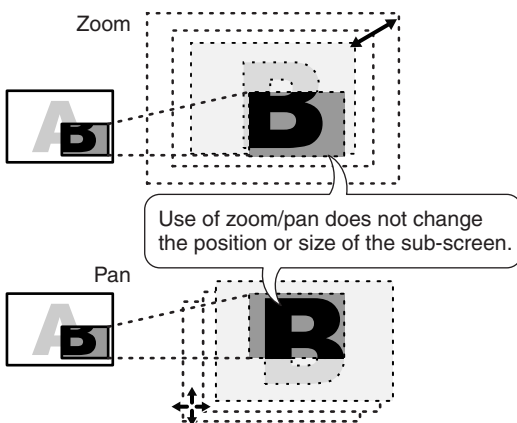
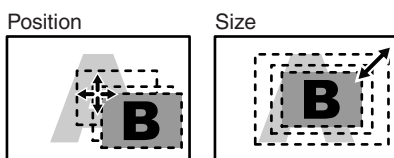

- You cannot select the WIPE [1]–[4] buttons (p. 38) when the P in P effect is on.

### 1 Output the video to be used as the background screen.

The channel select button lights in yellow.

### 2 Press the [P in P] button.

The [P in P] button lights up, and the P in P effect is switched on.

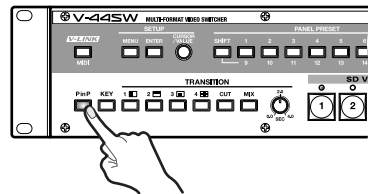

- Pressing the [P in P] button once more at this time switches off the P in P effect.

### 3 Press one of the SD VIDEO buttons [1]–[4] or the HD/RGB buttons [1]–[4] to select the input video to be shown in the sub-screen.

The selected button flashes in green, and the input video appears in the preview monitor connected to the HD/RGB OUT PREVIEW connector.

- The P in P effect is not applied at this stage. Select the video to use in the sub-screen while checking the video being previewed.

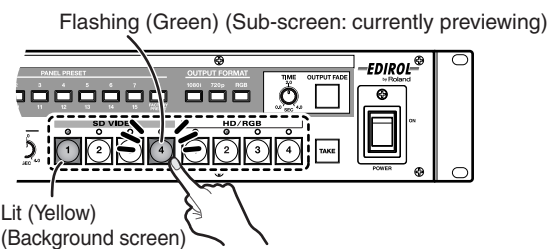

### 4 Once you decide to use the video in the sub-screen, press the [TAKE] button.

The video on the channel selected in Step 3 is placed in the sub-screen and output as the final output video.

- The sub-screen is alternately displayed and hidden each time the [TAKE] button is pressed. The [TAKE] button lights while the sub-screen is displayed.
- While the sub-screen is being displayed, you can switch the sub-screens just by pressing the channel select buttons.
- When Key Composite (p. 41) is in use, the key composite effect is applied to the video in the sub-screen.

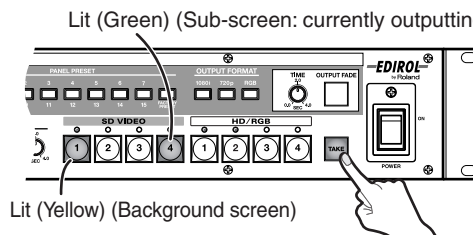

- For more on setting the sub-screen's position and size, border appearance, and other sub-screen settings, refer to "Advanced P in P Effect Settings" (p. 40).

- You can change the colors in which channel select buttons light. For more detailed information, refer to the column "About the Colors of Channel Select Buttons" (p. 36).

**About the Final Output When the P in P Effect is Off**

If the P in P effect is turned off while the sub-screen is still being displayed, the video on the channel assigned to the sub-screen at that time becomes the final output video.

If you do not want the final output video to switch, first press the [TAKE] button to hide the sub-screen, then switch off the P in P effect.

**Advanced P in P Effect Settings**

Use these procedures to adjust the sub-screen’s position and size, border appearance, and other sub-screen settings.

**1 Press the [MENU] button to display the Main menu.**

**2 Select “4. P in P/Zoom” to display the sub-menu.**

You can make changes to the following parameters.

4. P in P/Zoom Sub Menu (p. 56)	
1: Size	Sub-screen size adjustment
2: X Position	Sub-screen horizontal position adjustment
3: Y Position	Sub-screen vertical position adjustment
4: Zoom	Sub-screen zoom size adjustment
5: Pan X Position	Sub-screen panning horizontal position adjustment
6: Pan Y Position	Sub-screen panning vertical position adjustment
7: Border Size *1	Sub-screen border width adjustment
8: Border Color *1	Sub-screen border color adjustment
9: Border Edge *1	Sub-screen border edge setting Hard: Straight-line border edges Soft: Graduated border that fades away
10: Crop	Selects crop mode of sub screen For more detailed information, refer to “Adjusting the Field of View for the Sub-Screen” on this page.
11: P in P Reset	The sub-menu settings are returned to their factory default settings (p. 29).

\*1 No border is displayed when the Key Composite effect (p. 41) is switched on.

- You can register the sub-screen settings in the presets, making it simple to call up settings later on. For more detailed information, refer to “Registering Often-Used Settings (Panel Presets)” (p. 42).

**Adjusting the Field of View for the Sub-Screen**

The field of view for the sub-screen can be adjusted using the “10: Crop” settings as shown below.

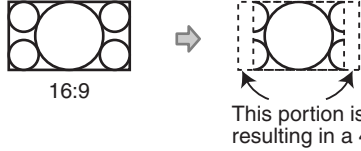
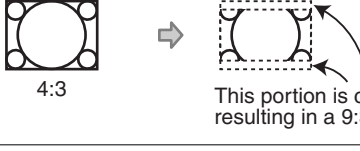
Value	Sub-Screen Aspect Ratio
Original	The sub-screen is displayed with the same aspect ratio as the background screen.
4:3	<p>If the video is input with an aspect ratio of 16:9, it is cropped and displayed in the sub-screen with the 4:3 aspect ratio.</p>  <p>This portion is cropped, resulting in a 4:3 aspect ratio.</p>
16:9	<p>If the video is input with an aspect ratio of 4:3, it is cropped and displayed in the sub-screen with the 16:9 aspect ratio.</p>  <p>This portion is cropped, resulting in a 9:3 aspect ratio.</p>



## Applying the Key Composite Effect

With this effect, the portions matching the key color in the video on the channel to which the key composite effect is applied are made transparent, and the video on the other channel is composited as shown in the figure below.

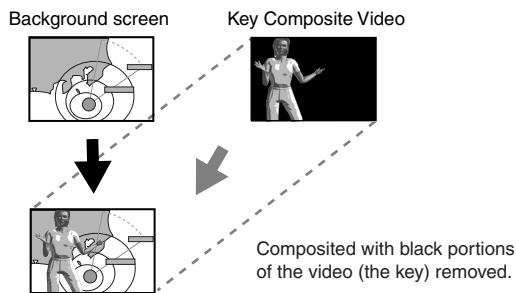

### 1 Output the video to be used as the background screen.

The corresponding channel select button lights in yellow.

### 2 Press the [KEY] button.

The [KEY] button lights up, and the Key Composite effect is switched on.

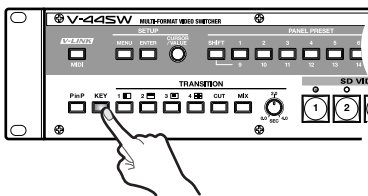

- Pressing the [KEY] button once more at this time switches off the Key Composite effect.

### 3 Press one of the SD VIDEO buttons [1]–[4] or the HD/RGB buttons [1]–[4] to select the key composite input video.

The selected button flashes in green, and the input video appears in the preview monitor connected to the HD/RGB OUT PREVIEW connector.

- The Key Composite effect is not applied at this stage. Select the key composite video while checking the video being previewed.

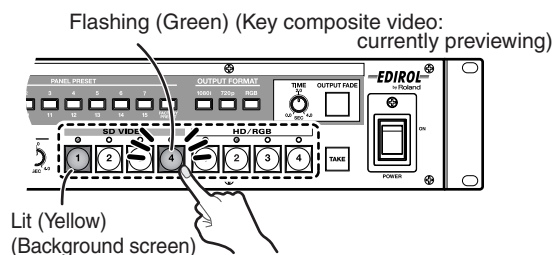

### 4 Once you decide on the video to use as the key composite video, press the [TAKE] button.

The Key Composite effect is switched on, and the video on the channel selected in Step 3 is placed in the sub-screen and output as the final output video.

- The key composite video is alternately displayed and hidden each time the [TAKE] button is pressed. The [TAKE] button lights while the key composite video is displayed.
- While the key composite video is being displayed, you can switch the video to be used as the key composite video just by pressing the channel select buttons.
- When the P in P effect (p. 39) is in use, the key composite effect is applied to the P in P sub-screen.

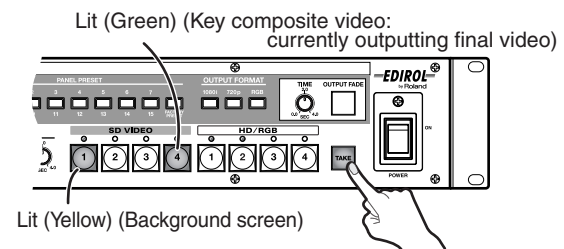

- For more on setting the key type, key level, and other Key Composite settings, refer to “Advanced Key Composite Settings.”

- You can change the colors in which channel select buttons light. For more detailed information, refer to the column “About the Colors of Channel Select Buttons” (p. 36).

## About the Final Output When the Key Composite Effect is Off

When the Key Composite effect is switched off while the key composite video is being displayed, the video on the channel being composited is made the final output video.

If you do not want to switch the final output video, first press the [TAKE] button to hide the key composite video, then switch off the Key Composite effect.

## Advanced Key Composite Settings

Use these procedures to adjust the key type, key level, and other settings.

### 1 Press the [MENU] button to display the Main menu.

### 2 Select “5. Key” to display the sub-menu.

You can make changes to the following parameters.

5. Key Sub Menu (p. 56)	
1: Key Type	Key Type
2: Key Level	Key level
3: Key Soft Edge	Key soft edge level
4: Key Reset	The sub-menu settings are returned to their factory default settings (p. 29).

- You can register the Key Composite settings in the presets, making it simple to call up these settings later on. For more detailed information, refer to “Registering Often-Used Settings (Panel Presets)” (p. 42).

# Registering Often-Used Settings (Panel Presets)

You can register button settings, settings for the Picture in Picture (P in P) and other special effects, and other settings as presets. You can register up to fifteen presets.

You can call up registered presets instantly just by pressing the PANEL PRESET buttons.

In addition, the original default settings programmed at the factory have already been registered as "Factory Preset."

Check the factory preset parameters in the table below to confirm the content registered in Factory Preset.

- You cannot export the content of registered presets.

## Settings Registered to the Presets

Settings	Factory Preset	See Page	
Buttons	[P in P] Button	Off	p. 39
	[KEY] Button	Off	p. 41
	TRANSITION Select Buttons	[MIX] Button	p. 38
	Channel Selection Buttons	SD VIDEO [1] Button	p. 36
P in P effect	Size	30%	p. 39
	X Position	-25%	
	Y Position	+25%	
	Zoom	105%	
	Pan X Position	0%	
	Pan Y Position	0%	
	Border Size	0	
	Border Color	Black	
	Border Edge	Hard	
Crop	Original		
Key composite effect	Key Type	Luminance Key2	p. 41
	Key Level	128	
	Key Soft Edge	3	
Other	Output Fade Mode	Auto	p. 28
	OUTPUT FADE Level	No fade	

## Registering Presets

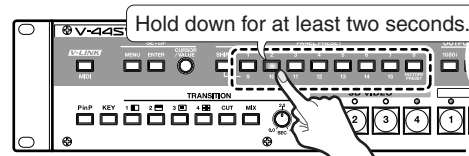

- Hold down the PANEL PRESET button for the preset number you want to register for at least two seconds.

Presets 1–8 can be registered when the [SHIFT] button is unlit (Presets 9–15 can be registered when the button is lit). When registration of the preset is completed, all of the PANEL PRESET buttons flash.

## Calling Up Presets

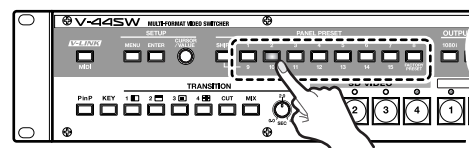

- Press the PANEL PRESET button for the preset number you want to call up.

Presets 1–8 can be called up when the [SHIFT] button is unlit (Presets 9–15 can be called up when the button is lit). The pressed button lights, and the preset is called up.

- You can confirm which preset is called up by checking the color in which the button lights.

Lit (Green)	Presets 1–8
Lit (Red)	Presets 9–15, Factory Preset
Off	No preset selected

### NOTE

- Use of certain functions together may result in disruption of the video images. We recommend testing settings configurations beforehand when switching presets.

## Calling Up the Factory Preset

- Press the [SHIFT] button so it's lit, then press the PANEL PRESET [FACTORY PRESET] button.

The Factory Preset is called up.

- Check the Factory Preset parameters in the table at the left to confirm the content registered to the Factory Preset.

### Fading Out the Output When Calling Up Presets

You can call up presets after you have started to fade out the output.

- 1 Press the [MENU] button to display the Main menu.
- 2 Select “7. Panel Preset Edit” and select “4: Set Preset Fade Time” from the sub-menu.
- 3 Set the fade time.  
You can set the fade time to any value from 0.0 to 4.0 seconds.

### Specifying the Parameters To Be Called Up with Presets

You can elect to have only specified parameter settings in a preset rather than all of the registered settings called up when you call up the preset.

- 1 Press the [MENU] button to display the Main menu.
- 2 Select “7. Panel Preset Edit” and select “3: Preset Play Select” from the sub-menu.
- 3 Set each parameter to “Free” or “Load.”  
Free: The settings are not called up.  
Load: The settings are called up.

7. Panel Preset Edit Preset → Play Select Sub Menu	
1: Output Fade	Output Fade Mode, OUTPUT FADE Level settings
2: Input	Channel select button settings
3: P in P	Picture in Picture settings
4: Key	Key Composite settings
5: Transition	TRANSITION select button settings
6: Preset Play Reset	The sub-menu settings are returned to their factory default settings (p. 29).

### Copying Presets

You can copy a preset to a different PANEL PRESET button and use that button for the preset.

#### NOTE

- When the copy is executed, the settings originally assigned to the copy-destination button are overwritten and lost.

- 1 Press the [MENU] button to display the Main menu.
- 2 Select “7. Panel Preset Edit” and select “1: Copy” from the sub-menu.
- 3 Select the preset to be copied and press the [ENTER] button.  
The preset shown at the left of the screen becomes the copy source.
- 4 Select the preset copy destination and press the [ENTER] button.  
The message “Are You Sure?” appears.
- 5 Select “Yes” and press the [ENTER] button.  
The preset is copied.

### Exchanging Presets Between PANEL PRESET Buttons

You can exchange the preset registered to one PANEL PRESET with the preset registered to another PANEL PRESET button.

- 1 Press the [MENU] button to display the Main menu.
- 2 Select “7. Panel Preset Edit” and select “2: Exchange” from the sub-menu.
- 3 Select the preset to be exchanged and press the [ENTER] button.  
The preset shown at the left of the screen becomes the exchange source.
- 4 Select the preset exchange destination and press the [ENTER] button.  
The message “Are You Sure?” appears.
- 5 Select “Yes” and press the [ENTER] button.  
The presets are exchanged.

# Using the V-44SW with Other Devices

## Using the V-44SW with a V-440HD for Multi-Screen Output

You can link V-44SWs with an Edirol V-440HD in a system of up to six devices to display a single video source across multiple screens. This function is referred to as “Multi-Screen Output.”

- When using Multi-Screen Output, you must have a V-440HD as the master device. The V-44SWs function as slave devices to the V-440HD.

<Conceptual Image of Output>

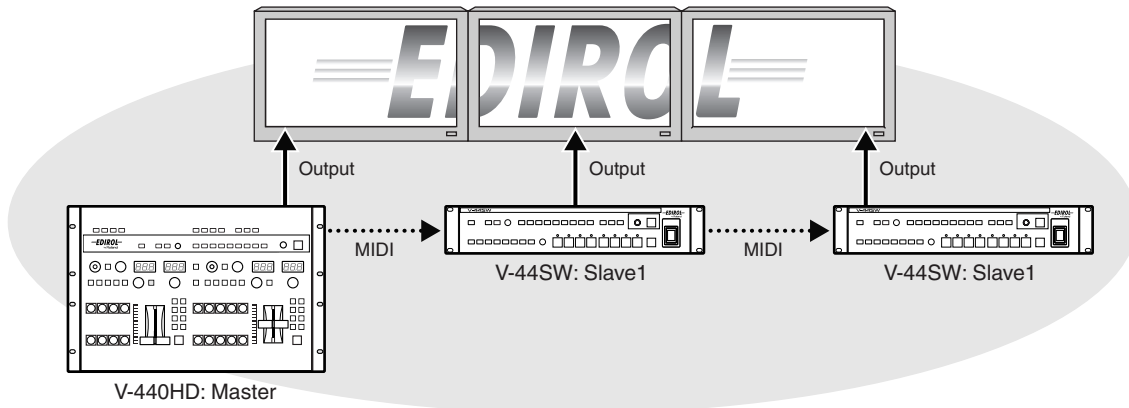

### ■ Switching the V-44SW’s Operating Modes

To have the V-44SW function as a slave device to the V-440HD, you need to switch the V-44SW to “V-440HD Slave mode.”

**1** Press the [MENU] button to display the Main menu.

**2** Select “8. System” and select “12: V-440HD Slave Mode” from the sub-menu.

**3** Set the parameter to “On.”

**4** Turn the V-44SW’s power off, then on again.

Start up the V-440HD in Slave mode. At this time, all of the PANEL PRESET buttons light up in orange.

To return to the normal operating mode, select “13. System” from the menu and set “21: V-440HD Slave Mode” to “Off,” then turn the V-44SW’s power off, then on again. The unit will start up in the normal mode.

- For more detailed instructions concerning use of Multi-Screen Output, refer to “Multi-Screen Output” in the V-440HD Owner’s Manual.
- When V-440HD Slave mode is in use, the V-440HD’s menu includes the following additional parameters. For more detailed information, refer to “Menu Parameters” in the V-440HD Owner’s Manual.

13. System Parameter	Explanation	Value
21: V-440HD Slave Mode	Switches V-440HD on and off	Off, On

\* The display “-----” indicates menu parameters that cannot be accessed from the V-44SW.

- The following buttons and knobs are enabled in V-440HD Slave mode.  
[MIDI] button, [MENU] button, [ENTER] button, [CURSOR/VALUE] knob, [1080i] button, [720p] button, [RGB] button

## Using MIDI

The V-44SW can be controlled from an external device using MIDI. You can, for example, control the V-44SW from a Roland MIDI-compatible product (e.g., a Fantom-X Series keyboard) to conduct video performances synchronized with sounds.

### ■ About MIDI

#### What is MIDI?

MIDI, an abbreviation for Musical Instrument Digital Interface, is an international standard created to enable exchange of performance data among devices. Any MIDI-compatible device can be connected simply with a MIDI cable, allowing transfer of performance data and control of device operations and settings.

#### MIDI Connectors

MIDI messages (data handled with MIDI). On the V-440HD, the MIDI OUT and MIDI THRU are combined in one connector. The function is switched according to the operation being performed.

**MIDI IN:** MIDI messages from other MIDI devices are received here.

**MIDI OUT:** MIDI messages from the V-440HD are transmitted from here.

**MIDI THRU:** MIDI messages received at the MIDI IN connector are output as is.

#### MIDI channels

MIDI is able to send information over a single MIDI cable independently to two or more MIDI devices. This is made possible by the concept of MIDI channels. You can think of MIDI channels as being somewhat similar in function to the channels on a television. By changing the channel of a TV set, you can view a variety of programs being transmitted by different broadcast stations. This is because data is received only from the transmitter whose channel is selected on the receiver.

In the same way, a MIDI device whose receive channel is set to "1" will receive only the data being transmitted by another MIDI device whose transmit channel is also set to "1."

#### MIDI Messages Handled by the V-44SW

The following MIDI messages are handled with the V-44SW.

- **Bank Select and Program Change**

These messages are used for switching tones.

On the V-44SW, these messages are used for selecting input channels.

- **Control Change Messages**

These generally transmit information, such as vibrato, hold, and volume, that enhances the realism of performances. All functions are organized according to a controller number from 0 to 127, with each function being assigned its own number.

On the V-44SW, these messages are used with the video faders and knobs.

- **System Exclusive Messages**

These messages are used for transmitting device-specific settings.

On the V-44SW, these messages are used for transmitting P in P settings and when setting the Multi Screen outputs.

When System Exclusive messages are exchanged, MIDI transmissions are distinguished by Device IDs rather than MIDI channels. When exchanging System Exclusive messages, set the devices to the same Device ID.

#### MIDI Implementation Chart

The use of MIDI makes it possible to communicate with a broad range of electronic musical instruments. However, this does not mean that all MIDI messages can be exchanged among all devices. Only those MIDI messages that both of the communicating devices are designed to understand can be exchanged. The owner's manual that comes with a MIDI device includes a MIDI Implementation Chart (p. 59).

Such charts allow you to easily find out which MIDI messages that device can transmit and receive. When using MIDI devices, compare the charts for the devices that will be communicating to check which MIDI messages are compatible.

## ■ Controlling the V-44SW from an External Device Via MIDI

When V-LINK mode (p. 48) is off, you can transmit the unit's button and knob operations using MIDI messages. Conversely, you can also use MIDI messages transmitted by external devices to control the V-44SW's button and knob settings.

- For more details about MIDI messages, refer to the MIDI Implementation. The MIDI Implementation can be downloaded from the Roland Systems Group website. <http://rolandsystemsgroup.net>

<Buttons and Knobs for Which MIDI Messages Are Received>

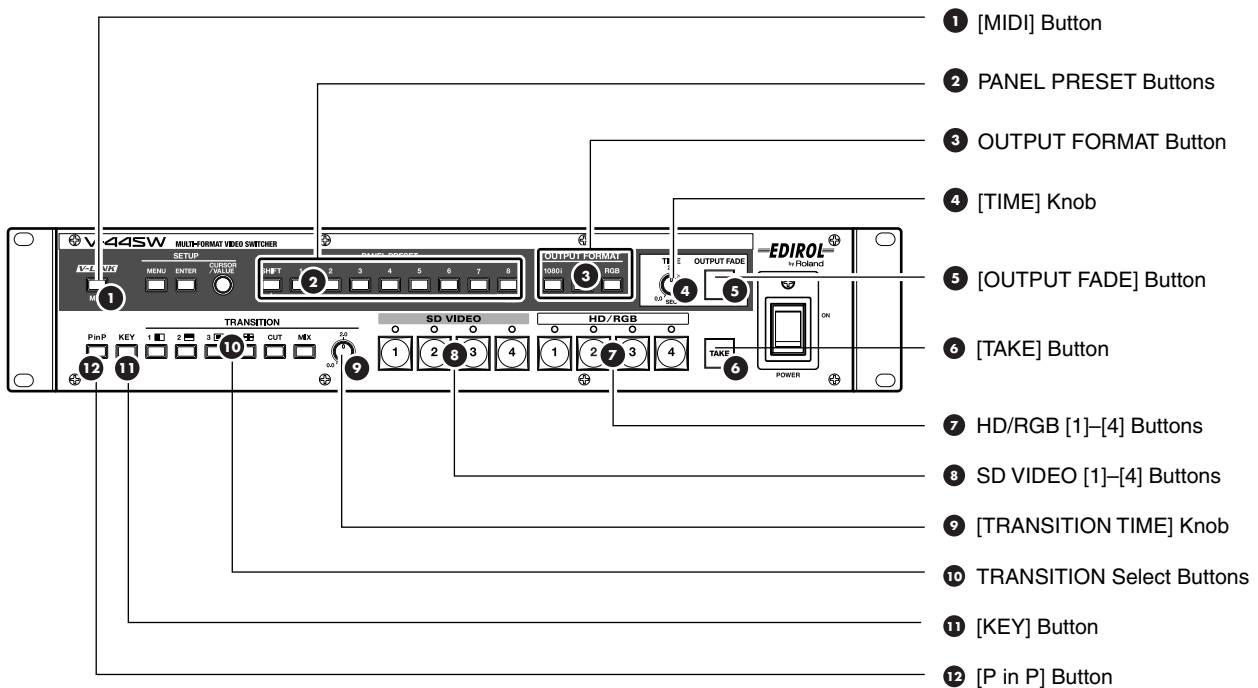

### Linking Operation Via MIDI

You can use MIDI to link operation of multiple V-44SWs.

- **If Linking Operation of Multiple V-44SWs**

Select "9. MIDI Setup" from the menu and set "4: MIDI Out/Thru Switch" as follows.

Master V-44SW: Out  
 V-44SWs other than the master: Thru

- **If Linking Operation to Use Multi-Screen Output**

For instructions on linking operation of V-440HDs and V-44SWs, refer to "Using the V-44SW with a V-440HD for Multi-Screen Output" (p. 44).

### Temporarily Cutting Linked Operation

You can stop reception of MIDI signals temporarily by pressing the [MIDI] button so its light is turned off. This stops linked operation via MIDI and enables independent functioning of one individual V-44SW.

To restore linked operation through MIDI, press the [MIDI] button once more so the button is lit.

## ■ Controlling the V-44SW from a PR-80/50

You can control the V-44SW remotely from an Edirol PR-80 or PR-50 (hereafter referred to as PR Series devices) via MIDI. The following operations can be controlled from the PR Series device.

- You can use the PR Series Scheduler function for automatic operation of the V-44SW.
- You can use the PR Series Scheduler for automatic operation of the V-44SW.

Use a PR Series device running ver. 1.2 or later.

### Connection Example

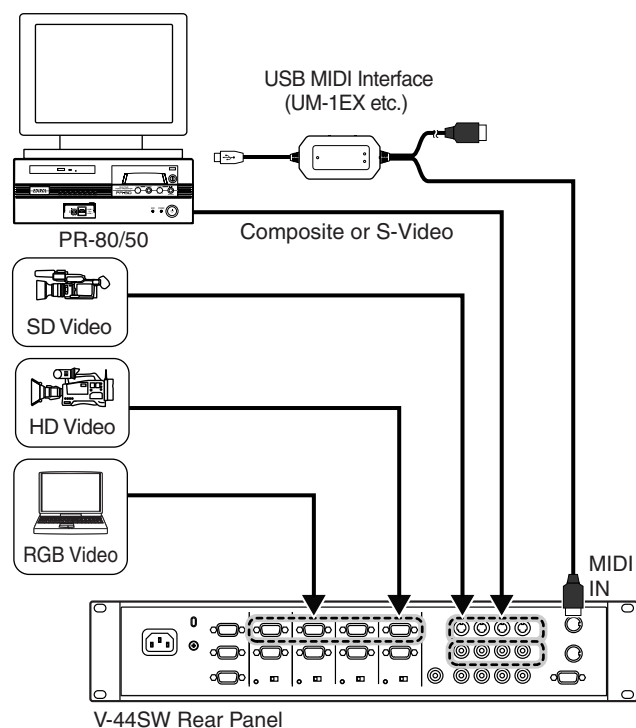

- Connect the video output from the PR Series device to one of the SD S-VIDEO connectors 1-4 or SD COMPOSITE connectors 1-4.
- For instructions on setting and operation of the PR series device, refer to the PR Series device Owner's Manual.

## ■ Transmitting Settings to Another V-44SW (Bulk Dump)

You can transmit one V-44SW's parameter settings to another V-44SW as MIDI data

### Making the Connections

Connect the MIDI OUT/THRU connector of the V-44SW transmitting the settings to the MIDI IN connector of the V-44SW receiving the settings.

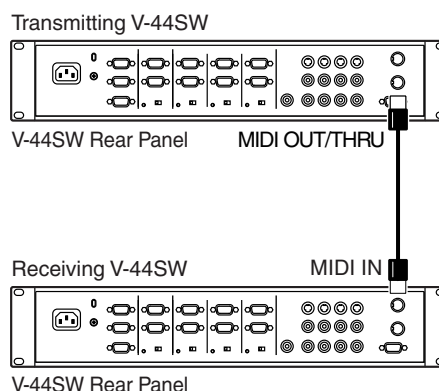

### NOTE

#### About the Receiving V-44SW

- When MIDI data is received, the settings on the receiving device are overwritten, and the previous settings are lost. If you want to save your settings, back up the V-44SW's settings to a computer. ☞ "Backing Up the V-44SW's Settings to a Computer" (p. 49).
- When using the V-44SW while linked with the V-440HD, the settings of the V-440HD can be transmitted to the V-44SW. In this case, the V-44SW's operational mode needs to be switched to "V-440HD Slave Mode" (p. 44).

If MIDI data is received from the V-440HD without switching the operational mode, the panel preset functionality (p. 42) of the V-44SW may fail to operate properly.

### Procedure

- Before beginning the bulk dump, be sure the Device ID setting is the same for both the transmitting and receiving device.  
Set the Device ID with "6: Device ID" under "9: MIDI Setup" in the menu.

- 1 Press the [MENU] button to display the Main menu.
- 2 Select "9: MIDI Setup" and then select "18: MIDI Bulk Dump" from the sub-menu.
- 3 Select "Yes."
- 4 Press the [ENTER] button.  
The MIDI data is transmitted from the transmitting V-44SW.

## Control Using V-LINK

### What is V-LINK?

V-LINK ( **V-LINK** ) is a function that allows music and images to be performed together. By using MIDI to connect two or more V-LINK compatible devices, you can easily enjoy performing a wide range of visual effects that are linked to the expressive elements of a music performance.

### How to Use V-LINK

When V-LINK mode is on, you can have control of the V-44SW be synchronized to the performance of a V-LINK compatible instrument (such as the Fantom-X).

- For more on how to switch V-LINK mode on and off, refer to the Owner's Manual of the V-LINK compatible device connected to the V-44SW.
- To see which functions can be controlled from the external device while V-LINK mode is in effect, refer to the MIDI Implementation for the connected device and the V-44SW's MIDI Implementation. The functions that can be controlled may vary according to the connected device and the settings.

The MIDI Implementation for the V-44SW can be downloaded from the Roland Systems Group website.

<http://rolandsystemsgroup.net>

- You can have the [MIDI] button light up or go off to show whether V-LINK mode is on or off. Select "9. MIDI Setup" in the menu and set "1: MIDI Sw Mode" to "V-LINK Indicator."

### Initial V-LINK Status Settings

Parameters settings under the initial V-LINK status (whereby the V-44SW receives only the V-LINK ON message) are shown below.

Parameter	Initial Status
Rx Channel	1
Tx Channel	1
Channel Select Buttons	SD VIDEO [1] button
TRANSITION Select Buttons	[MIX] button
[TRANSITION TIME] Knob	0.0 (sec.)
[KEY] Button	OFF
[P in P] Button	OFF
PANEL PRESET Buttons	OFF
Output Fade Mode	Auto
OUTPUT FADE Level	MAX (No fade)

## Controlling the V-44SW from an External Device Using the REMOTE Connector

You can use the REMOTE connector to enable switching, control of effects, and other operations from a computer or other external control device.

### About Connections

The V-44SW's REMOTE connector is a 9-pin male D-sub connector. Be sure to use an RS-232C cable to connect the control device.

An RS-232C cable (D-Sub, 9-pin, female-female) is the proper cable for connecting a computer.

Cable Connections:

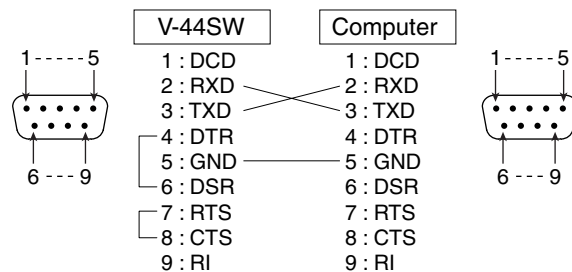

- Use an RS-232C cable with a connector that matches the connector on your device.

### Setup Procedure

- 1 Connect the V-44SW and control device with an RS-232C cable.
- 2 Turn on the power to the control device.
- 3 Set the communications protocol for the control device.
- 4 Turn on the power to the V-44SW.
- 5 Begin operation.

- For more detailed information about commands, refer to the "REMOTE Command Reference" (p. 60).



## Backing Up the V-44SW's Settings to a Computer

You can back up and restore the V-44SW's settings by transmitting data between the V-44SW and a computer.

- This function requires software supporting backup and restore procedures.
- With the V-44SW, use the "Serial Data Tool" software used in backing up the V-440HD's settings (for Windows XP only). This software can be downloaded from the Roland Systems Group website.

<http://rolandsystemsgroup.net>

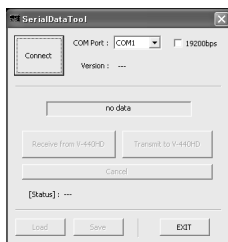

### Making the Connections

Connect the computer and the V-44SW as shown in the diagram below.

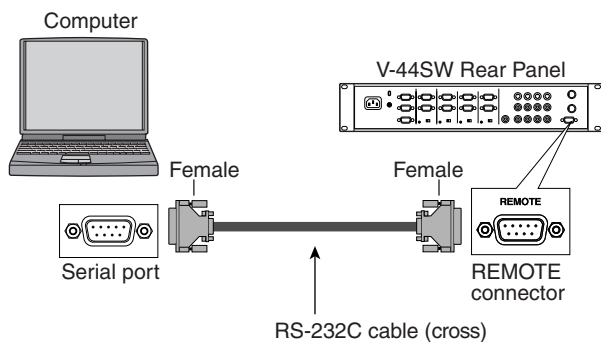

- Connect the computer using an RS-232C cable (D-Sub, 9-pin female-female cross cable).
- If using the USB port, use a USB-to-serial adapter, and make the settings necessary to ensure that the serial port functions normally.
- For details of the pin assignments for the V-44SW's REMOTE connector, refer to "Connector Specifications: REMOTE Connector" (p. 62).

### Procedure

- You can change the baud rate setting with "4: REMOTE Baudrate" under "8. System" in the menu.

- 1 Using the computer, set the application so it is in a standby state, waiting for data reception.
- 2 Press the [MENU] button to display the Main menu.
- 3 Select "8. System" and then select "9: All Data Transmit" from the sub-menu.
- 4 Select "Yes."
- 5 Press the [ENTER] button.

Transmission of the data begins. The progress of the transfer is indicated at the bottom of the screen as a percentage.

- Transfer of all of the data is completed in approximately 30 seconds.
- To cancel transmission while it is still in progress, press the [MENU] button.

### Restoring Settings From a Computer

The V-44SW constantly receives data transmitted from the computer. Use the computer's software to transfer and restore data to the V-44SW.



# Appendices

# Troubleshooting

If you suspect a malfunction, please check the following points. If this does not resolve the problem, contact a nearby EDIROL/Roland Service Center or an authorized EDIROL/Roland distributor.

## Video Output

### Video not being output

- **Devices are connected incorrectly**

Properly reconnect the devices.

- “Device Connections” (p. 14)
- “About Connection Cables Used with the Component Inputs and Outputs” (p. 63)

- **Correct output format is not selected**

Check to confirm that the format selected is appropriate for the display or projector connected to the HD/RGB OUT PGM connector, and if necessary, reselect the output format by pressing the OUTPUT FORMAT [1080i], [720p], or [RGB] button.

- “Setting the Output Format” (p. 30)

You can change the output format selected with each of the OUTPUT FORMAT buttons. Select “1. Output” in the menu and check “1: Output Format (1080i)” – “3: Output Format (RGB)” to confirm whether or not the format is properly selected.

- “Changing the Output Format” (p. 30)

### Output video is disrupted

- **Final output is not locked**

Changing the V-44SW’s output format (p. 30) may prevent locking of the video with the display or projector.

If this occurs, try turning off the power and then turning the devices on again in the following sequence.

- Transmitting device (e.g., video deck) → V-44SW
- Display or projector

- **Video is being output in a format incompatible with the display or projector**

The video may be disrupted if the video output from the V-44SW is in a format that is not compatible with the receiving display or projector.

Find out the formats supported by your display or projector and reselect an appropriate output format.

- “Setting the Output Format” (p. 30)

- **The V-44SW is connected to a device requiring a reference signal (black burst signal)**

The V-44SW does not input or output reference signals (black burst signals). For this reason, video images may become disrupted if you connect the V-44SW to a device that requires a reference signal. If this occurs, use the following methods of avoiding disruption of the video images.

- Input the Y signal from the V-44SW’s HD/RGB OUT PGM connector to the reference signal input connector on the connected device.
- Switch the device requiring the reference signal to a mode that uses reference signals within the component signals.

## Video input to the HD/RGB IN connectors disrupted

- **Video barely stabilizing**

Depending on the state of the video signals being input, there may be difficulties in locking the video when the video is switched by pressing the HD/RGB [1]–[4] buttons.

In such situations, select “3. HD/RGB Input” in the menu and set “1: Format Auto Detect” to “Manual,” then select the input format with the “2: Input Format” setting.

## Motion of video input to HD/RGB is shaky

- **Video being input with differing System Frame Rate settings**

When the video format uses a different frame rate than the system frame rate set for the V-44SW, the video image may at times move in a disjointed fashion due to the frame rate conversion processing required.

- “Selecting NTSC or PAL Format” (p. 35)

- **Video being input with frame rate different than that for the output format**

When the video format uses a different frame rate than the frame rate set for the V-44SW’s output format, the video image may at times move in a disjointed fashion due to the frame rate conversion processing required.

- “Setting the Output Format” (p. 30)

## Problems with aspect ratio of video input using RGB signals

- **Settings do not match the screen’s aspect ratio**

In some instances, the aspect ratio of the screen displaying the finished video may not match the aspect ratio of the RGB input video. Adjust the settings to achieve the correct aspect ratio.

- “About the Scaling Type” (p. 33)

- **The RGB input’s horizontal synchronization is set to a rate other than 60 Hz or 75 Hz**

If the horizontal synchronization of the RGB video is not set to 60 Hz or 75 Hz, the video image may end up being extended in the vertical direction.

- **Signals do not conform to VESA standards**

Some devices output RGB signals that do not conform to VESA standards. When such signals are used, the screen image may be extended vertically or horizontally as a result.

If adjusting the aspect ratio, select “3. HD/RGB Input” from the menu, then set “5: Scaling Type” to “Manual.” Follow this by making the settings for “6. Manual X Scale” through “9. Y Position.”

- “Setting the HD/RGB Input” (p. 32)

- “About the Scaling Type” (p. 33)

### Screen shows visible vertical discrepancies

Since the V-44SW handles video with differing aspect ratios, if you do not scale (enlarge/reduce) the input video to match the output format, the screen aspect ratio may not display properly.

For each input channel, set the “Scaling Type” parameter under “3. HD/RGB Input” in the menu to adjust the aspect ratio.

The screen aspect ratio may be distorted if the format of the output video does not match the settings of the device receiving HD output or RGB output.

→ “About the Scaling Type” (p. 33)

### Not all of the video appearing in the screen

There may be instances in which not all of the video output from the V-44SW appears in the display. This may be due to differences in the size of the region in which video is not displayed (the safe area) for some displays. To adjust the video size so that it does not reach into the safe area, set “5: Zooming” under “1. Output” in the menu.

### Colors for input video odd

As the V-44SW inputs and outputs HD, RGB, and SD signals in analog format, differences in color may occur, even with the same video material, due to individual differences from one device to another. Make the settings for each individual input.

→ “Setting the HD/RGB Input” (p. 32)

→ “Setting the SD Input” (p. 34)

## Effects

### Video images disrupted when video is switched

- **When using the screen transition effects (wipe or mix)**

When using the screen transition effects (wipe or mix), the video images may be disrupted at the moment the wipe or mix effect is most fully applied. To prevent disruption of the video, try switching the video after first switching completely to the subsequent video.

- **When using the P in P or key composite effects**

Disruption of the video images may occur when the video is switched while the sub-screen or key composite video is displayed. To prevent disruption of the video, switch the video after first switching off the P in P or key composite effect.

### Video image not being removed properly with the key effects

Select “5. Key” from the menu and adjust the value of the “3: Soft Edge” setting. If the value is set too high, portions of the video not belonging to the key image may also end up being masked.

Use video input that features a high signal-to-noise ratio. For example, you can achieve better key composite results with HD key images than with SD key images.

## Switching Video

### Video images disrupted when video is switched

- **When using the screen transition effects (wipe or mix)**

When using the screen transition effects (wipe or mix), the video images may be disrupted at the moment the wipe or mix effect is most fully applied. To prevent disruption of the video, try switching the video after first switching completely to the subsequent video.

- **When using the P in P or key composite effects**

Disruption of the video images may occur when the video is switched while the sub-screen or key composite video is displayed. To prevent disruption of the video, switch the video after first switching off the P in P or key composite effect.

### Switching of video delayed

Selecting an HD/RGB channel to which no signals are input may result in delayed switching of the video; this does not indicate a malfunction.

## Other

### V-44SW becoming heated

- **The cooling fan exhaust vents are blocked**

Anything happening to impede the cooling fan exhaust vents will prevent proper cooling of the V-44SW, causing temperatures inside the V-44SW to rise. As this may result in damage to the V-44SW, be sure not to place any obstructions near the exhaust vents.

- **Other equipment is stacked on top of the V-44SW**

Setting other devices directly on top of the V-44SW may result in heat from these devices being transferred to the V-44SW, thus causing the V-44SW to overheat. In such situations, be sure to provide adequate space between other devices and the V-44SW.

### Odd noises coming from inside the unit

- **Debris is caught in the cooling fan exhaust vents**

If any foreign matter happens to be caught up in the cooling fan, it can cause audible noises from the interior of the V-44SW, and may even lead to damage. Do not place any object liable to enter the exhaust vent near the vent.

If something does get inside the exhaust vent and you are unable to remove it from the outside, contact the nearest EDIROL/Roland Service Center, listed on the back page of the warranty card.

# Menu List

## Main menu

This is the Main menu list displayed when the [MENU] button is pressed.

Parameters	Explanation	Sub Menu
1. Output	Settings for the final output are made here.	p. 54
2. SD Input	SD input settings are made here.	p. 55
3. HD/RGB Input	HD/RGB input settings are made here.	p. 55
4. P in P/Zoom	Advanced settings P in P effect are made here.	p. 56
5. Key	Advanced settings key composite effects are made here.	p. 56
6. Wipe Select	Wipe effect settings are made here.	p. 57
7. Panel Preset Edit	Panel presets are managed here.	p. 57
8. System	The V-44SW's system settings are made here.	p. 58
9. MIDI Setup	MIDI-related settings are made here.	p. 58
10. Factory Reset	This restores the V-44SW to its original factory default settings.	--- (Procedure:  p. 29)

## Sub Menus

### 1. Output Settings for the final output are made here.

Parameters	Explanation	Values
1: Output Format (1080i) Sw	Output format assigned to OUTPUT FORMAT [1080i] button	Refer to "About the Final Output Format" below.
2: Output Format (720p) Sw	Output format assigned to OUTPUT FORMAT [720p] button	
3: Output Format (RGB) Sw	Output format assigned to OUTPUT FORMAT [RGB] button	
4: Output Format Sw Lock	OUTPUT FORMAT button lock	Off, On
5: Zooming	Final output scaling adjustment	80.0–120.0
6: Bright	Final output brightness adjustment	-64–+64
7: Contrast	Final output contrast adjustment	-64–+64
8: Saturation	Final output saturation adjustment	-64–+64
9: Red	Final output red adjustment	-64–+64
10: Green	Final output green adjustment	-64–+64
11: Blue	Final output blue adjustment	-64–+64
12: Output Fade Mode	Final output fade control adjustment	Auto, Manual
13: Output Fade Color	Final output fade color setting	Black, White
14: Test Pattern Select	Selects the Test Pattern to output	Off, 75% Color Bar, 100% Color Bar
15: Output Reset	The sub-menu settings are returned to their factory default settings	--- (Procedure:  p. 29)

### About the Final Output Format

You can select from the following formats for use with the final output.

Component		RGB		
<NTSC>	<PAL>	1366x768/75	1280x768/75	800x600/75
1080/60i	1080/50i	1366x768/60	1280x768/60	800x600/60
720/60p	720/50p	1280x1024/60	1024x768/75	640x480/75
480/60p	576/50p		1024x768/60	640x480/60
480/60i	576/50i			

\* The selectable component format changes as above depending on the setup for "1: System Frame Rate" under "8. System."

\* RGB units: horizontal (pixels) x vertical (lines) / frame rate (Hertz)

## 2. SD Input SD input settings are made here.

Parameters	Explanation	Sub Menu
1: SD Ch1	Sets video input to Channel 1 of the SD IN connectors	Refer to "SD Ch Sub Menu" below.
2: SD Ch2	Sets video input to Channel 2 of the SD IN connectors	
3: SD Ch3	Sets video input to Channel 3 of the SD IN connectors	
4: SD Ch4	Sets video input to Channel 4 of the SD IN connectors	

### SD Ch Sub Menu

Parameters	Explanation	Values
1: SD Input Select	Selects the SD input	Auto, S-Video, Composite
2: SD Brightness	Brightness adjustment	-63~+63
3: SD Contrast	Contrast adjustment	-8~+7
4: SD Saturation	Saturation adjustment	-128~+127
5: SD Hue	Hue adjustment	-128~+127
6: SD Sw Enable	Sets the Enable/Disable status for the channel select buttons	Off, On
7: SD Reset	The sub-menu settings are returned to their factory default settings	--- (Procedure:  p. 29)

## 3. HD/RGB Input HD/RGB input settings are made here.

Parameters	Explanation	Sub Menu
1: HD/RGB SD	Sets input for SD video input to HD/RGB section	Refer to "HD/RGB SD, HD/RGB Ch Sub Menu" below.
2: HD/RGB Ch1	Sets video input to Channel 1 of the HD/RGB IN connectors	
3: HD/RGB Ch2	Sets video input to Channel 2 of the HD/RGB IN connectors	
4: HD/RGB Ch3	Sets video input to Channel 3 of the HD/RGB IN connectors	
5: HD/RGB Ch4	Sets video input to Channel 4 of the HD/RGB IN connectors	

### HD/RGB SD, HD/RGB Ch Sub Menu

\* Refer to the following page for notes requiring attention.

Parameters	Explanation	Values
1: Format Auto Detect *1 *2	Function automatically distinguishes input	Auto, Manual
2: Input Format *1 *2	Selects input format	Refer to "About the HD/RGB Input Format" (p. 56).
3: Pre Scaling Mode	Switches scaling adjustment function	Auto, Manual
4: Manual Pre Scaling *3	Adjusts scaling ratio when full scaling used	90.0~110.0%, Auto
5: Scaling Type	Selects the scaling method	Full Scale, Fixed Aspect: Letter, Fixed Aspect: Crop, Manual
6: Manual X Scale *4	Adjusts the horizontal expansion ratio	10~+1000%
7: Manual Y Scale *4	Adjusts the vertical expansion ratio	10~+1000%
8: X Position	Fine adjustment of the horizontal start position	-200~+200
9: Y Position	Fine adjustment of the vertical start position	-200~+200
10: Brightness	Brightness adjustment	-64~+64
11: Contrast	Contrast adjustment	-64~+64
12: Saturation	Saturation adjustment	-64~+64
13: Red	Red adjustment	-64~+64
14: Green	Green adjustment	-64~+64
15: Blue	Blue adjustment	-64~+64
16: Frequency *1	Fine adjustment of the Sampling Frequency	-200~+200
17: Phase *1	Fine adjustment of the Sampling Phase	-64~+64
18: Sw Enable *1	Sets the Enable/Disable status for the channel select buttons	Off, On
19: Input Ch Reset	The sub-menu settings are returned to their factory default settings	--- (Procedure:  p. 29)

- \*1 Cannot be set in HD/RGB SD. Parameter numbers are in sequence, with these parameters omitted.
- \*2 Enabled when Format Auto Detect is set to Manual.
- \*3 Enabled when Pre Scaling Mode is set to Manual.  
The “Manual Pre Scaling” setting has no effect in the P in P effect (p. 39) sub-screen.
- \*4 Enabled when Scaling Type is set to Manual.

**About the HD/RGB Input Format**

The V-44SW inputs component and RGB video in the formats shown in the following table.

Component		RGB		
480/60p	1080/50i	640x480/60	800x600/75	1280x768/60
576/50p	720/60p	640x480/75	1024x768/60	1280x768/75
1080/60i	720/50p	800x600/60	1024x768/75	1280x1024/60

\* RGB units: horizontal (pixels) x vertical (lines) / frame rate (Hertz)

**4. P in P/Zoom** Advanced settings P in P effect are made here.

Parameters	Explanation	Values
1: Size	Sub-screen size adjustment	20–100% (Changes according to the sub-screen position)
2: X Position	Sub-screen horizontal position adjustment	-50–+50% (Changes according to the sub-screen position)
3: Y Position	Sub-screen vertical position adjustment	-50–+50% (Changes according to the sub-screen position)
4: Zoom	Sub-screen zoom size adjustment	100–1000%
5: Pan X Position	Sub-screen panning horizontal position adjustment	-100.0–+100.0%
6: Pan Y Position	Sub-screen panning vertical position adjustment	-100.0–+100.0%
7: Border Size *1	Sub-screen border width adjustment	0–15
8: Border Color *1	Sub-screen border color adjustment	Black, Red, Green, Yellow, Blue, Magenta, Cyan, White
9: Border Edge *1	Sub-screen edge setting	Hard, Soft
10: Crop	Selects crop mode of sub screen	Original, 4:3, 16:9
11: P in P Reset	The sub-menu settings are returned to their factory default settings	--- (Procedure:  p. 29)

\*1 No border is displayed when the Key Composite effect (p. 41) is switched on.

**5. Key** Advanced settings key composite effects are made here.

Parameters	Explanation	Values
1: Key Type	Key type	Luminance Key1(White), Luminance Key2 (Black), Chroma Key1 (Blue), Chroma Key2 (Green)
2: Key Level	Key level	0–255
3: Key Soft Edge	Soft edge level	0–15
4: Key Reset	The sub-menu settings are returned to their factory default settings	--- (Procedure:  p. 29)



## 6. Wipe Select

Wipe effect settings are made here.



Parameters	Explanation	Sub Menu
1: Wipe Sw1	Sets WIPE [1] button	Refer to “Wipe Sw Sub Menu” below.
2: Wipe Sw2	Sets WIPE [2] button	
3: Wipe Sw3	Sets WIPE [3] button	
4: Wipe Sw4	Sets WIPE [4] button	

### Wipe Sw Sub Menu

Parameters	Explanation	Values
1: Wipe Pattern	Wipe pattern setting	Horizontal, Vertical, Horizontal Open, Vertical Open, Box, Cross
2: Wipe Reverse	Reverses the direction of the wipe effect	Off, On
3: Wipe Edge Type	Soft edge type setting	Hard, Soft
4: Wipe Reset	The sub-menu settings are returned to their factory default settings	--- (Procedure:  p. 29)

## 7. Panel Preset Edit



Panel presets are managed here.

Parameters	Explanation	Values
1: Copy	Copies the panel preset	--- (Procedure:  p. 43)
2: Exchange	Exchanges the panel preset with a different panel preset	--- (Procedure:  p. 43)
3: Preset Play Select	Settings for each parameter in the registered content to be called up	Refer to “Preset Play Select Sub Menu” below.
4: Set Preset Fade Time	Fade-out time when switched with PANEL PRESET	0.0–4.0 (sec.)
5: Preset Reset	The sub-menu settings are returned to their factory default settings	--- (Procedure:  p. 29)



### Preset Play Select Sub Menu

Parameters	Explanation	Values
1: Output Fade	Output Fade Mode and OUTPUT FADE Level settings	Free, Load
2: Input	Channel select button's setting	Free, Load
3: P in P	P in P effect settings	Free, Load
4: Key	Key composite effect settings	Free, Load
5: Transition	TRANSITION select button's setting	Free, Load
6: Preset Play Reset	The sub-menu settings are returned to their factory default settings	--- (Procedure:  p. 29)

**8. System** The V-44SW's system settings are made here.

Parameters	Explanation	Values
1: System Frame Rate	Switches between NTSC and PAL	60-NTSC, 50-PAL
2: SD Deinterlacer	SD section I/P conversion function	Off, On
3: SD Input Sync Threshold	SD input sync level adjustment	-48~+79
4: REMOTE Baudrate	REMOTE bit rate setting	9600bps, 19200bps
5: Seamless Delay Time	Delay time when channel select buttons are used	0-50 (Field)
6: HD/RGB On Screen Display	Displays HD/RGB PGM/PREVIEW output in menu	Off, On
7: Panel Operation Mode	Sets the mode used for switching the video	Direct Mode, Preset Mode
8: Input Sw LED Color	Sets the colors of the channel select button indicators	Main=YEL : Sub=GRN Main=YEL : Sub=RED Main=RED : Sub=GRN Main=RED : Sub=YEL Main=GRN : Sub=RED Main=GRN : Sub=YEL
9: All Data Transmit	Transmits the V-44SW's settings from the REMOTE connector.	--- (Procedure:  p. 49)
10: System Reset	The sub-menu settings are returned to their factory default settings	--- (Procedure:  p. 29)
11: Memory Protect	Menu settings protect function	Off, On
12: V-440HD Slave Mode	Switches V-440HD Slave Mode on and off	Off, On

**9. MIDI Setup** MIDI-related settings are made here.

Parameters	Explanation	Values
1: MIDI Sw Mode	[MIDI] button function	MIDI In/Out Sw, V-LINK Indicator
2: MIDI Tx Channel	Sets MIDI Transmit channel	1-16
3: MIDI Rx Channel	Sets MIDI Receive channel	1-16, Off
4: MIDI Out/Thru Switch	MIDI OUT/THRU connector function	Out, Thru
5: V-LINK Switch	Switches the V-LINK Slave function on and off	Off, On
6: Device ID	Device ID setting	00H-1FH
7: Panel Preset Tx Type	PANEL PRESET (p. 42) transfer method	Settings, Number Only
8: Take Switch Assign	[TAKE] button MIDI assign	Off, CC#01-CC#95, ChAftTt, PitchBD
9: Transition Assign	TRANSITION button MIDI assign	Off, CC#01-CC#95, ChAftTt, PitchBD
10: Transition Time	[TRANSITION TIME] knob MIDI assign	Off, CC#01-CC#95, ChAftTt, PitchBD
11: Video Fader Assign	Internal video fader MIDI assign	Off, CC#01-CC#95, ChAftTt, PitchBD
12: Key Sw Assign	[KEY] button MIDI assign	Off, CC#01-CC#95, ChAftTt, PitchBD
13: P in P Sw Assign	[P in P] button MIDI assign	Off, CC#01-CC#95, ChAftTt, PitchBD
14: Panel Preset Sw Assign	PANEL PRESET button MIDI assign	Off, CC#01-CC#95, ChAftTt, PitchBD
15: Output Format Sw Assign	OUTPUT FORMAT button MIDI assign	Off, CC#01-CC#95, ChAftTt, PitchBD
16: Fade Sw Assign	[OUTPUT FADE] button MIDI assign	Off, CC#01-CC#95, ChAftTt, PitchBD
17: Fade Level Assign	[TIME] knob MIDI assign	Off, CC#01-CC#95, ChAftTt, PitchBD
18: MIDI Bulk Dump	Transmits the settings to MIDI-connected devices	--- (Procedure:  p. 47)
19: MIDI Reset	The sub-menu settings are returned to their factory default settings	--- (Procedure:  p. 29)

# MIDI Implementation Chart

MULTI-FORMAT VIDEO SWITCHER

Date : Oct. 10, 2006

Model V-44SW

## MIDI Implementation Chart

Version : 1.00

Function...	Transmitted	Recognized	Remarks
Basic Channel Default Changed	1 1-16	1 1-16	
Mode Default Messages Altered	Mode 3 X *****	Mode 3 X *****	
Note Number : True Voice	X X	X X	
Velocity Note On Note Off	X X	X X	
After Touch Key's Channel's	X ○	X ○	Control various parameters
Pitch Bend	○	○	Control various parameters
Control Change	0, 32 ○ 1-5 ○ 7-31 ○ 64-95 ○	○ ○ ○ ○	Select inputs Control various parameters Control various parameters Control various parameters
Program Change : True Number	○ 0-7	○ 0-7	Select inputs: 1-8
System Exclusive	○	○	Set parameters, V-LINK
System Common : Song Position : Song Select : Tune Request	X X X	X X X	
System Real Time : Clock : Commands	X X	X X	
Aux Messages : All Sound Off : Reset All Controllers : Local On/Off : All Notes Off : Active Sensing : System Reset	X X X X ○ X	X X X X X X	
Notes			

Mode 1 : OMNI ON, POLY  
Mode 3 : OMNI OFF, POLY

Mode 2 : OMNI ON, MONO  
Mode 4 : OMNI OFF, MONO

○ : Yes  
X : No

# REMOTE Command Reference

- For more information on transmission settings, refer to “Controlling the V-44SW from an External Device Using the REMOTE Connector” (p. 48).

## Overview of Commands

A command consists of an ASCII code sequence containing “stx,” three uppercase letters of the alphabet, and a semicolon (“;”). The three letters of the alphabet indicate the command type.

If the command has an argument, a colon (“:”) is inserted between the two letters of the alphabet and the argument. When multiple arguments occur, they are separated by commas (“,”).

<b>stx</b>	This is the ASCII code signal name (code number 02H [hexadecimal]) and code that signals the command start.
<b>:</b>	This is the code used by the Presenter to separate the command and its arguments.
<b>;</b>	This is the code used by the Presenter to signify the end of a command.

<Example 1> When transmitting the input channel select command  
→ The ASCII code string stxINP:0; is transmitted.

<Example 2> When setting the P in P horizontal placement at 40%, vertical placement at -20%, and size at 30%  
→ The ASCII code string stxPIP:40,-20,30; is transmitted.

## Commands Transmitted from External Devices to the V-44SW

In the following, stx (02H), ACK (06H), and Xon (11H) / Xoff (13H) are control codes.

- \* When transmitting commands to the V-44SW from an external device, be sure that ACK is returned before transmitting the next command.

### INP Input Channel Select

**stxINP:a;**

- a:** Channel number  
(0–7, 0: SD IN 1 Channel, 1: SD IN 2 Channel, 2: SD IN 3 Channel, 3: SD IN 4 Channel, 4: HD/RGB IN 1 Channel, 5: HD/RGB IN 2 Channel, 6: HD/RGB IN 3 Channel, 7: HD/RGB IN 4 Channel)

This selects the input channels.

ACK is returned by the V-44SW upon proper reception of the command.

- \* When “Panel Operation Mode” is set to “Direct Mode,” the inputs switch as the different input channels are selected.
- \* \* When “Panel Operation Mode” is set to “Preset Mode,” following selection of the input channel, the inputs are then switched when the [TAKE] button is pressed to select the input.

### VDF Internal Video Fader Position

**stxVDF:a;**

- a:** Internal video fader position  
(0–255, 0: PGM position, 255: Preset position)

This specifies the internal video fader position.

ACK is returned by the V-44SW upon proper reception of the command.

- \* When “Panel Operation Mode” is set to “Direct Mode,” this is used only when P in P or KEY is switched on.
- \* When “Panel Operation Mode” is set to “Preset Mode,” this is executed after selection of the input channel.

### TIM TIME Knob Setting

**stxTIM:a;**

- a:** Time (0.0–4.0)

ACK is returned by the V-44SW upon proper reception of the command.

### TAK TAKE Button Select

**stxTAK:a;**

- a:** Time (0.0–4.0)

Inputs are switched in the time set for the parameter.

ACK is returned by the V-44SW upon proper reception of the command.

- \* When “Panel Operation Mode” is set to “Direct Mode,” this is used only when P in P or KEY is switched on.
- \* When “Panel Operation Mode” is set to “Preset Mode,” this is executed after selection of the input channel.

### TRS TRANSITION Button Select

**stxTRS:a;**

- a:** TRANSITION button number

(0: CUT, 1: MIX, 2: WIPE 1, 3: WIPE 2, 4: WIPE 3, 5: WIPE 4)

This selects the TRANSITION button for the effect used in switching.

ACK is returned by the V-44SW upon proper reception of the command.

### PIP P in P Effect Setting

**stxPIP:a,b,c;**

- a:** P in P horizontal position (%) (-50–50)

- b:** P in P vertical position (%) (-50–50)

- c:** P in P size (%) (0, 20–100)

This makes the settings for the P in P effect.

Setting the P in P size to 0 switches off the P in P.

ACK is returned by the V-44SW upon proper reception of the command.

### ZOM ZOOM Effect Setting

**stxZOM:a,b,c;**

- a:** Pan horizontal position (%) (-99–99)

- b:** Pan vertical position (%) (-99–99)

- c:** Zoom size (x10%) (10–100)

This sets the Pan and Zoom for the P in P currently being displayed.

- \* This has no effect when the P in P is not displayed.

### KEY Key Composite ON

**stxKEY:a,b;**

- a:** Key composite status (0–4 (0: OFF, 1: Luminance Key1, 2: Luminance Key 2, 3: Chroma Key 1, 4: Chroma Key 2)

- b:** Key Level (0–255)

This sets the key composite type and key level applied when the Key Composite On/Off is set to On.

ACK is returned by the V-44SW upon proper reception of the command.

### PSE PANEL PRESET Select

**stxPSE:a;**

- a:** PANEL PRESET number

(0–14: PANNEL PRESET 1–15, 15: FACTORY PRESET)

This selects the PANEL PRESET settings.

ACK is returned by the V-44SW upon proper reception of the command.

### OUT OUTPUT FORMAT Button Select

**stxOUT:a;**

**a:** 0–2 (0: 1080i, 1: 720p, 2: RGB)

This selects the OUTPUT FORMAT button, changing the format of the video output.

ACK is returned by the V-44SW upon proper reception of the command.

### FAD OUTPUT FADE Operation

**stxFAD:a;**

**a:** OUTPUT FADE status

(0–255, 0: FADE MAX, 255: VIDEO MAX)

This sets the concentration during fadeouts of the video output from the HD/RGB OUT PGM connectors.

ACK is returned by the V-44SW upon proper reception of the command.

### RST V-44SW Reset

**stxRST;**

This resets the V-44SW's panel status, with the Factory Presets called up.

ACK is returned by the V-44SW upon proper reception of the command.

### VER Version Information Request

**stxVER;**

Transmit this when you want to check the V-44SW's version. The version information is returned.

- \* For more details on version information, refer to "VER Version Information" on this page.

### ACS Active Sensing Request

**stxACS;**

Transmit this when you want to check the V-440HD's status.

ACK is returned when no operation is being performed by the V-44SW.

### DAT Data Transmission

**stxDAT:aaaa,bbbb;**

**aaaa:** Address (aaaa, bbbb are in hexadecimal)

**bbbb:** Data

This overwrites the data at the specified address.

After the required data is transmitted, FFFF,xxxx; is transmitted as the final string of the command, and the data is written (xxxx represents the data version).

ACK is returned when no operation is being performed by the V-44SW.

- \* The "Serial Data Tool" application are available from the Roland Systems Group website. For more detailed information, refer to the column "Serial Data Transmissions" on this page.

### XON Flow Control

**XON**

### XOFF Flow Control

**XOFF**

## Commands Transmitted from the V-44SW to External Devices

In the following, stx (02H), ACK (06H), and Xon (11H) / Xoff (13H) are control codes.

### ACK Acknowledgment of Proper Reception

**ACK**

This is transmitted when a command is received properly.

### ERR Error Information

**stxERR:a;**

**a:** 0 (syntax error)

Error in the syntax of the received command.

2 (busy error)

V-44SW busy, command cannot be processed.

5 (out of range error)

Number in received command is out of range.

20 (something error)

Other error. Transmitted when the V-44SW is unable to process the command properly

### VER Version Information

**stxVER: "a", "b", "c";**

**a:** Model Name (V-44SW)

**b:** Version

**c:** Reserved

This is transmitted when the V-440SW receives a VR command version. The version information is transmitted as an ASCII character string.

### DAT Data Transmission

**stxDAT:aaaa,bbbb;**

**aaaa:** Address (aaaa, bbbb are in hexadecimal)

**bbbb:** Data

The data is transmitted to the specified address.

After the required data is transmitted, FFFF,xxxx; is transmitted as the final string of the command, and the data is written (xxxx represents the data version).

- \* The "Serial Data Tool" application are available from the Roland Systems Group website. For more detailed information, refer to the column "Serial Data Transmissions" on this page.

### XON Flow Control

**XON**

### XOFF Flow Control

**XOFF**

#### Serial Data Transmissions

The following data and application have been made available by the Roland system Group. You may download and use these materials.

<http://rolandsystemsgroup.net>

- "Serial Data Tool" V-440HD settings backup and restore tool (for Windows XP only)

The "Serial Data Tool" for the V-440HD may also be used with the V-44SW.

# Connector Specifications

## HD/RGB IN OUT Connectors

### Inputting and Outputting Analog Component Signals

- Connector Type: D-sub 15-pin shrink terminal (female)

Pin number	Signal name	Pin Connections
1	Pr	
2	Y	
3	Pb	
4	GND	
5	GND	
6	Pr-GND	
7	Y-GND	
8	Pb-GND	
9	N.C.	
10	GND	
11	(Reserved)	
12	-	
13	-	
14	-	
15	-	
FG	Frame GND	

### Inputting and Outputting RGB Signals

- Connector Type: D-sub 15-pin shrink terminal (female)

Pin number	Signal name	Pin Connections
1	Red	
2	Green	
3	Blue	
4	GND	
5	GND	
6	R-GND	
7	G-GND	
8	B-GND	
9	N.C.	
10	SYNC-GND	
11	(Reserved)	
12	(VESA DDC RESERVED)	
13	H-SYNC	
14	V-SYNC	
15	(VESA DDC RESERVED)	
FG	Frame GND	

## REMOTE Connector

- Connector Type: D-sub 9-pin terminal (male)
- Transmission Format: Start-stop synchronization (asynchronous), full duplex
- Transmission Rate: 9600 bps (Initial setting)/19200 bps  
\* This can be changed in the menu with "4. REMOTE Baudrate" under "8. System."
- Parity: None
- Data Length: 8 bits
- Stop Bit Length: 1 bit
- Encoding: ASCII
- Flow Control: XON/XOFF

Pin number	Signal name	Pin Connections
1	DCD	
2	RXD	
3	TXD	
4	DTR	
5	GND	
6	DSR	
7	RTS	
8	CTS	
9	RI	

# About Connection Cables Used with the Component Inputs and Outputs

You can use a D-sub to 5-BNC cable to connect the component inputs and outputs. Check the D-sub to 5-BNC wiring diagram, then correctly connect the (three) BNC connectors.

\* Be sure to use cables and adapter plugs with the proper connectors matching those of the other devices you are using.

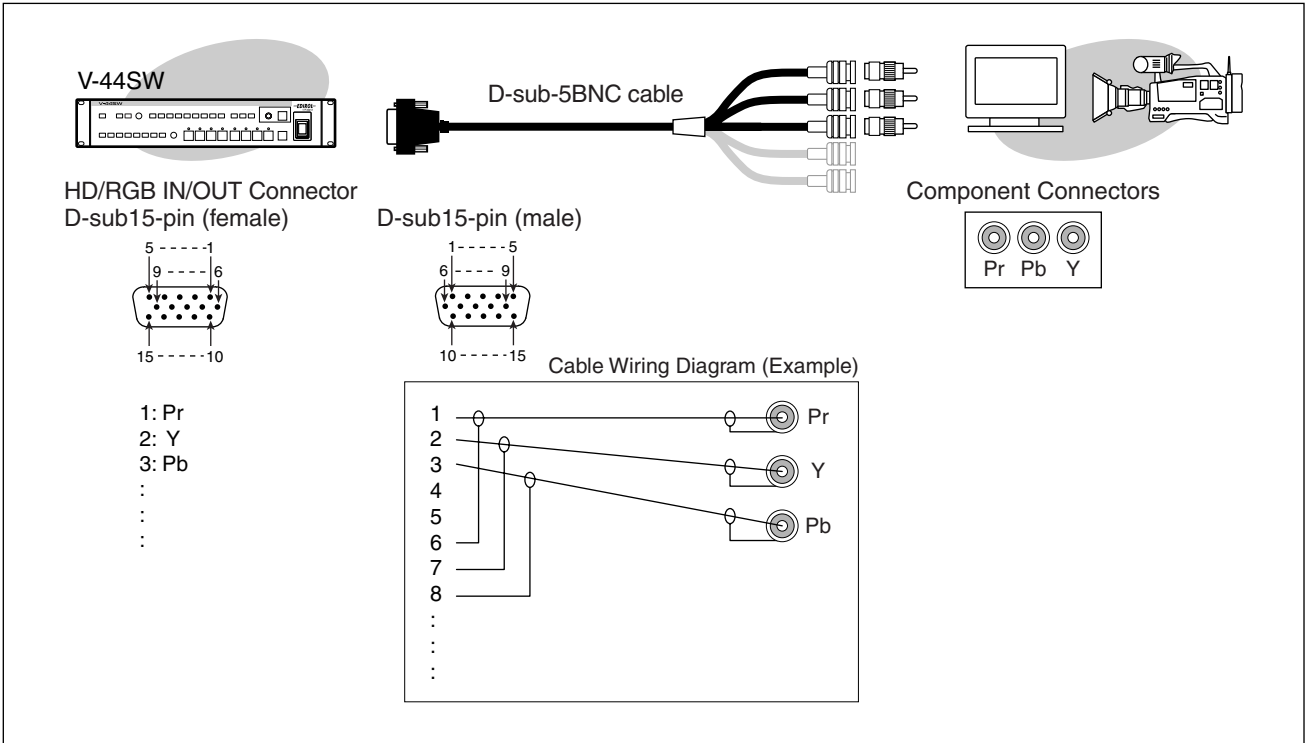

# Menu Settings Memo

## 1. Output

1: Output Format (1080i) Sw	
2: Output Format (720p) Sw	
3: Output Format (RGB) Sw	
4: Output Format Sw Lock	
5: Zooming	
6: Bright	
7: Contrast	
8: Saturation	
9: Red	
10: Green	
11: Blue	
12: Output Fade Mode	
13: Output Fade Color	
14: Test Pattern Select	

## 2. SD Input

(SD Ch)	1	2	3	4
1: SD Input Select				
2: SD Brightness				
3: SD Contrast				
4: SD Saturation				
5: SD Hue				
6: SD Sw Enable				

## 3. HD/RGB Input

(HD/RGB)	SD	Ch1	Ch2	Ch3	Ch4
1: Format Auto Detect					
2: Input Format					
3: Pre Scaling Mode					
4: Manual Pre Scaling					
5: Scaling Type					
6: Manual X Scale					
7: Manual Y Scale					
8: X Position					
9: Y Position					
10: Brightness					
11: Contrast					
12: Saturation					
13: Red					
14: Green					
15: Blue					
16: Frequency					
17: Phase					
18: Sw Enable					

## 4. P in P/Zoom

1: Size	
2: X Position	
3: Y Position	
4: Zoom	
5: Pan X Position	
6: Pan Y Position	
7: Border Size	
8: Border Color	
9: Border Edge	
10: Crop	

## 5. Key

1: Key Type	
2: Key Level	
3: Key Soft Edge	

## 6. Wipe Select

(Wipe Switch)	1	2	3	4
1: Wipe Pattern				
2: Wipe Reverse				
3: Wipe Edge Type				

## 7. Panel Preset Edit

1: Copy		
2: Exchange		
3: Preset Play Select	1: Output Fade	
	2: Input	
	3: P in P	
	4: Key	
	5: Transition	
4: Set Preset Fade Time		



<b>8. System</b>	
1: System Frame Rate	
2: SD Deinterlacer	
3: SD Input Sync Threshold	
4: REMOTE Baudrate	
5: Seamless Delay Time	
6: HD/RGB On Screen Display	
7: Panel Operation Mode	
8: Input Sw LED Color	
9: V-440HD Slave Mode	

<b>9. MIDI Setup</b>	
1: MIDI Sw Mode	
2: MIDI Tx Channel	
3: MIDI Rx Channel	
4: MIDI Out/Thru Switch	
5: V-LINK Switch	
6: Device ID	
7: Panel Preset Tx Type	
8: Take Switch Assign	
9: Transition Assign	
10: Transition Time	
11: Video Fader Assign	
12: Key Switch Assign	
13: P in P Switch Assign	
14: Panel Preset Sw Assign	
15: Output Format Sw Assign	
16: Fade Switch Assign	
17: Fade Level Assign	



# Block Diagram

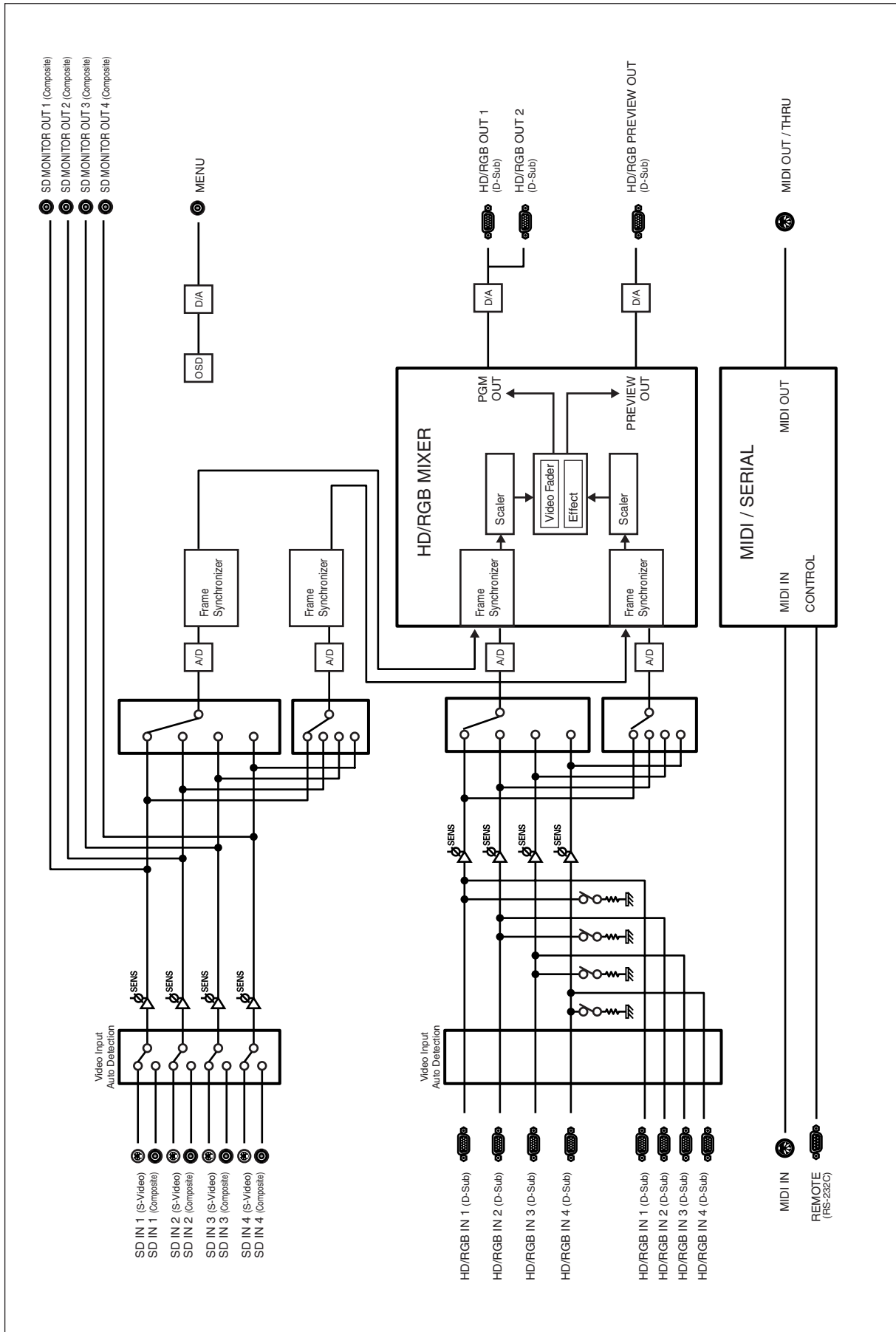

# Main Specifications

## V-44SW: MULTI-FORMAT VIDEO SWITCHER

Video Processing		
Video Format:	SD	NTSC or PAL [CVBS, S (Y/C)]
	HD	1080/59.94i/50i SMPTE274M (Y/Pb/Pr TriLevel Sync) 720/59.94p/50p SMPTE296M (Y/Pb/Pr TriLevel Sync)
	RGB	Input: 640 x 480/60/75, 800 x 600/60/75, 1024 x 768/60/75, 1280 x 1024/60 * RGB VH: positive/negative logic * VESA DMT Version 1.0 Revision 10 conform Output: 640 x 480/60/75, 800 x 600/60/75, 1024 x 768/60/75, 1280 x 768/60/75, 1280 x 1024/60, 1366 x 768/60/75 * VESA DMT Version 1.0 Revision 10 conform
Video Sampling Rate:	SD	4:2:2 (Y/Cb/Cr), 8 bits, 13.5 MHz (BT.601)
	HD	4:4:4 (Y/Pb/Pr), 8 bits, 74.1758 MHz/74.25 MHz
	RGB	4:4:4 (R/G/B), 8 bits, 25 MHz to 110 MHz
Effects	Video Transition	Cut Dissolve Wipe: 6 Patterns, Reverse, SoftEdge
	Composition FX	Luminance Key (White/Black) Chroma Key (Blue/Green) Picture in Picture with Zoom/Pan

Functions		
Multi-Screen Presentation	Screen Setup	2 screens x 1 line, 3 screens x 1 line, 2 screens x 2 lines, 3 screens x 2 lines * For Multi-Screen setup, V-44SW works as slave unit only. V-440HD is required as a master unit.
Synchronization Multiple Units by MIDI		
Master Fade		0 to 4 seconds, Black or White

Connectors		
SD Input	S-Video (Y/C) Preferential x 4	4-pin mini DIN type (Y: 1.0 Vp-p, C: 0.286 Vp-p, 75 ohms)
	Video (composite) x 4	BNC type (1.0 Vp-p, 75 ohms)
HD/RGB Input	HD/RGB x 4	HD/RGB x 4: D-Sub 15-pin Shrink Type HD: Y/Pb/Pr (1.0 Vp-p, 75 ohms, TriLevel Sync) RGB: R/G/B (0.7 Vp-p, 75 ohms), H (5VTTL), V (5VTTL)
HD/RGB Loop Thru Output	HD/RGB x 4	D-Sub 15-pin Shrink Type * Output signal from the same numbered input channel.
MENU Output	Setup Menu (composite) Output	BNC type (1.0 Vp-p, 75 ohms)
HD/RGB Output OSD Menu Output (selectable Display)	PGM Component HD/RGB x 2	D-sub 15-pin Shrink Type HD: Y/Pb/Pr (1.0 Vp-p, 75 ohms, TriLevel Sync) RGB: R/G/B (0.7 Vp-p, 75 ohms), H (5VTTL), V (5VTTL)
	Preview Component HD/RGB x 1	D-sub 15-pin Shrink Type HD: Y/Pb/Pr (1.0 Vp-p, 75 ohms, TriLevel Sync) RGB: R/G/B (0.7 Vp-p, 75 ohms), H (5VTTL), V (5VTTL)
Remote Control Interfaces	MIDI (In, Out/Thru)	5-pin DIN Type
	RS-232C	D-Sub 9-pin Type

Others	
Power Supply	AC 117 V, AC 230 V, AC 240 V (50/60 Hz), AC 220 V (60 Hz)
Power Consumption	50 W
Dimensions	482 (W) x 308 (D) x 88 (H) mm 19 (W) x 12-1/8 (D) x 3-1/2 (H) inches * EIA-2U Rack Mount Size
Weight	6 kg 13 lbs 4 oz
Accessories	Owner's Manual, V-44SW Operation Reference, Power Cord

\* In the interest of product improvement, the specifications and/or appearance of this unit are subject to change without prior notice.

# Index

## Numerics

- 16:9 Output ..... 18
- 4:3 Output ..... 20

## A

- Aspect ratio ..... 33
- Automatically setting (RGB input) ..... 32

## B

- Background screen ..... 39, 41
- Backing up ..... 49
- Bulk dump ..... 47

## C

- Channels ..... 9
- Color bars ..... 35
- Crop ..... 40
- Cut ..... 38

## D

- Delaying the output ..... 31
- Direct mode ..... 36

## E

- Effects ..... 38, 39

## F

- Factory default settings ..... 29
- Factory preset ..... 42
- Factory reset ..... 29
- Fade color ..... 28
- Fade in ..... 28
- Fade out ..... 28
- Fade time ..... 28
- Frame rate ..... 35

## H

- HD size (16:9) output ..... 18
- HD video deck ..... 21
- HD/RGB input ..... 32
- HD-SDI ..... 21
- High Definition ..... 4, 18

## I

- Input ..... 32, 34
- Input formats ..... 32, 34

## K

- Key composite ..... 41

## L

- LED display ..... 20
- Loop thru ..... 15

## M

- Menu ..... 26
  - Changing the value ..... 27
  - Closing ..... 27
  - Display monitor ..... 13, 26
  - Displaying ..... 27
  - Getting ready to display ..... 26
  - Levels ..... 26
  - List ..... 54
  - Locking out ..... 27
  - Saving ..... 27
  - Selecting parameters ..... 27
  - Shortcuts ..... 27
- MIDI ..... 45
- Mix ..... 38
- Multi-screen ..... 44

## N

- NTSC ..... 35

## O

- Operating modes ..... 44
- Output ..... 30
- Output formats ..... 30, 31
  - Changing ..... 30

## P

- P in P ..... 39
- PAL ..... 35
- Pan ..... 39
- Panel presets ..... 42
  - Calling up ..... 42
  - Copying ..... 43
  - Exchanging ..... 43
  - Registering ..... 42
- Picture in picture ..... 39
- Plasma display ..... 18
- PR series ..... 47
- Preset mode ..... 36, 37
- Presets ..... 42
- Projector ..... 19

## R

- Rack mounting ..... 13
- REMOTE connector ..... 48
- Reset ..... 29
- Restoring ..... 49
- RGB input ..... 32
  - Automatically setting ..... 32
- RGB Video ..... 19
- RS-232C cable ..... 48

**S**

Scaling ..... 33  
Scaling type ..... 33  
SD input ..... 34  
SD size (4:3) output ..... 20  
Serial Data Tool ..... 49  
Slave Mode ..... 44  
Soft edge ..... 38  
Sub-screen ..... 39  
Switching mode ..... 36  
Sync-on-green ..... 15

**T**

Test pattern ..... 35  
TIME knob ..... 28  
TRANSITION ..... 38  
Transition effects ..... 38

**V**

V-440HD ..... 44  
V-440HD Slave Mode ..... 44  
Video Switching Mode  
    Selecting ..... 36  
Video switching mode ..... 36  
V-LINK ..... 48

**W**

Wipe ..... 38  
Wipe pattern ..... 38

**Z**

Zoom ..... 39



For EU Countries

This product complies with the requirements of European Directives EMC 89/336/EEC and LVD 73/23/EEC.

For the USA

## FEDERAL COMMUNICATIONS COMMISSION RADIO FREQUENCY INTERFERENCE STATEMENT

This equipment has been tested and found to comply with the limits for a Class B digital device, pursuant to Part 15 of the FCC Rules. These limits are designed to provide reasonable protection against harmful interference in a residential installation. This equipment generates, uses, and can radiate radio frequency energy and, if not installed and used in accordance with the instructions, may cause harmful interference to radio communications. However, there is no guarantee that interference will not occur in a particular installation. If this equipment does cause harmful interference to radio or television reception, which can be determined by turning the equipment off and on, the user is encouraged to try to correct the interference by one or more of the following measures:

- Reorient or relocate the receiving antenna.
- Increase the separation between the equipment and receiver.
- Connect the equipment into an outlet on a circuit different from that to which the receiver is connected.
- Consult the dealer or an experienced radio/TV technician for help.

This device complies with Part 15 of the FCC Rules. Operation is subject to the following two conditions:

- (1) This device may not cause harmful interference, and
- (2) This device must accept any interference received, including interference that may cause undesired operation.

Unauthorized changes or modification to this system can void the users authority to operate this equipment.  
This equipment requires shielded interface cables in order to meet FCC class B Limit.

For Canada

## NOTICE

This Class B digital apparatus meets all requirements of the Canadian Interference-Causing Equipment Regulations.

## AVIS

Cet appareil numérique de la classe B respecte toutes les exigences du Règlement sur le matériel brouilleur du Canada.

For the USA

## DECLARATION OF CONFORMITY Compliance Information Statement

Model Name : V-44SW  
Type of Equipment : MULTI-FORMAT VIDEO SWITCHER  
Responsible Party : Roland Systems Group U.S.  
Address : 425 Sequoia Drive Suite 114, Bellingham, Washington, 98226 USA  
Telephone : (360) 594-4282



This product must be disposed of separately  
at your local waste recycling centre.  
Do not dispose of in household waste bin.

## Information

When you need repair service, call your nearest EDIROL/Roland Service Center or authorized EDIROL/Roland distributor in your country as shown below.

### ASIA

#### CHINA

Roland Shanghai Electronics Co.,Ltd.  
5F. No.1500 Pingliang Road  
Shanghai 200090, CHINA  
TEL: (021) 5580-0800

Roland Shanghai Electronics Co.,Ltd.  
(BEIJING OFFICE)  
10F. No.18 3 Section Anhuaxili  
Chaoyang District Beijing  
100011 CHINA  
TEL: (010) 6426-5050

#### KOREA

KOREA AVICS CO., LTD.  
463-3 Sunghwa bldg. 3rd F.,  
Seokyo-Dong, Mapo-ku,  
Seoul, KOREA  
Tel: 02-322-3264

#### TAIWAN

ROLAND TAIWAN  
ENTERPRISE CO., LTD.  
Room 5, 9fl. No. 112 Chung Shan  
N.Road Sec.2, Taipei, TAIWAN,  
R.O.C.  
TEL: (02) 2561 3339

#### SINGAPORE/ MALAYSIA

Roland Asia Pacific Sdn. Bhd.  
45-1, Block C2, Jalan PJU 1/39,  
Dataran Prima, 47301 Petaling  
Jaya, Selangor, MALAYSIA  
TEL: 3-7805-3263

### CENTRAL/LATIN AMERICA

Roland Systems Group U.S.  
425 Sequoia Drive Suite 114,  
Bellingham, Washington,  
98226 USA  
TEL: 360-594-4282

### EUROPE

AUSTRIA/GERMANY/  
ITALY/IRELAND/  
UNITED KINGDOM  
EDIROL (Europe) Ltd.  
Studio 3.4 114 Power Road  
London W4 5PY  
U. K.  
TEL: (0)20 8747 5949

BELGIUM/FRANCE/  
LUXEMBOURG/  
SWITZERLAND/  
HOLLAND/SPAIN/  
PORTUGAL  
Roland Iberia, S.L.  
Paseo Garcia Faria, 33-35  
08005 Barcelona SPAIN  
TEL: 93 493 91 00

#### DENMARK

Roland Scandinavia A/S  
Nordhavnsvej 7, Postbox 880,  
DK-2100 Copenhagen  
DENMARK  
TEL: 3916 6200

#### FINLAND

Roland Scandinavia As,  
Filiat Finland  
Elannontie 5  
FIN-01510 Vantaa, FINLAND  
TEL: (0)9 68 24 020

#### NORWAY

Roland Scandinavia Avd.  
Kontor Norge  
Lilleakerveien 2 Postboks 95  
Lilleaker N-0216 Oslo  
NORWAY  
TEL: 2273 0074

#### SWEDEN

Roland Scandinavia A/S  
SWEDISH SALES OFFICE  
Danvik Center 28, 2 tr.  
S-131 30 Nacka SWEDEN  
TEL: (0)8 702 00 20

#### HUNGARY

Roland East Europe Ltd.  
Warehouse Area 'DEPO' Pf.83  
H-2046 Torokbalint, HUNGARY  
TEL: (23) 511011

#### CZECH REP.

K-AUDIO  
Kardasovska 626.  
CZ-198 00 Praha 9,  
CZECH REP.  
TEL: (2) 666 10529

#### POLAND

MX MUSIC SP.Z.O.O.  
UL. Gibraltarska 4.  
PL-03664 Warszawa POLAND  
TEL: (022) 679 44 19

#### ROMANIA

FBS LINES  
Piata Libertatii 1,  
535500 Gheorgheni, ROMANIA  
TEL: (266) 364 609

#### RUSSIA

MuTek  
Dorozhnaya ul.3,korp.6  
117 545 Moscow, RUSSIA  
TEL: (095) 981-4967

#### UKRAINE

TIC-TAC  
Mira Str. 19/108  
P.O. Box 180  
295400 Munkachevo, UKRAINE  
TEL: (03131) 414-40

### OCEANIA

#### Roland Corporation Australia Pty., Ltd.

38 Campbell Avenue  
Dee Why West, NSW 2099  
AUSTRALIA

For Australia  
Tel: (02) 9982 8266  
For New Zealand  
Tel: (09) 3098 715

### NORTH AMERICA

#### CANADA

Roland Canada Ltd.  
(Head Office)  
5480 Parkwood Way, Richmond  
B. C., V6V 2M4 CANADA  
TEL: (604) 270 6626

Roland Canada Ltd.  
(Toronto Office)  
170 Admiral Boulevard  
Mississauga ON L5T 2N6  
CANADA  
TEL: (905) 362 9707

#### U. S. A.

Roland Systems Group U.S.  
425 Sequoia Drive Suite 114,  
Bellingham, Washington,  
98226 USA  
TEL: 360-594-4282

As of August 1, 2006 (EDIROL-2)



\* 0 4 3 4 8 0 3 4 - 0 1 \*

04348034

06-10-1N